

Campeggi



IF I COULD ONLY TRANSFORM MYSELF INTO SOMETHING SPECIAL, JUST LIKE MY FRIENDS!



BUT ONE NIGHT, WHILE I WAS DREAMING-

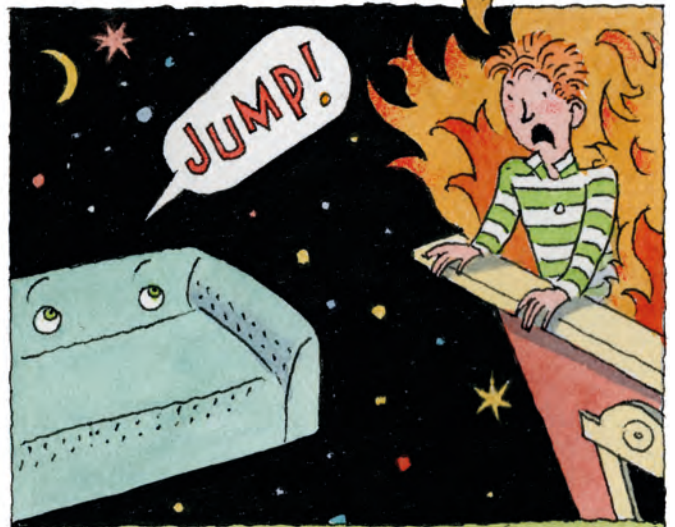

SOMEONE WAS TRAPPED IN A BURNING BUILDING!

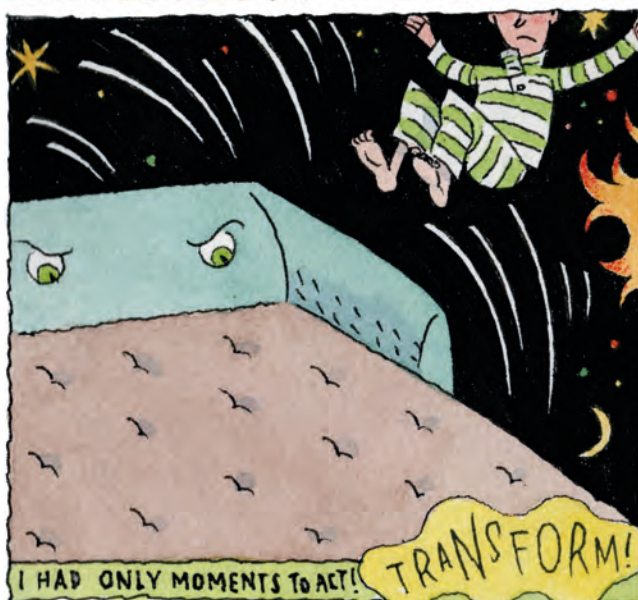

I HAD ONLY MOMENTS TO ACT!

TRANSFORM!



PEACE AT LAST, AND BACK TO THE PAESE DEI SOGNI!

Campeões

CAMPEGGI



5	Le cose cambiano Things are changing	116	LETTO TRASVERSALE / TRANSVERSE BED
6	Campeggi Timeline	120	PRONTO LETTO AD ALZATA FRONTALE READY-TO-USE BED WITH FRONT LIFT
8	Company Profile	128	LETTO A LIBRO - MECCANISMO A PETTINE BOOK-STYLE BED - COMB MECHANISM
12	Divani e Divani Letto Sofa and Sofa Bed	132	DIVANO / SOFA
18	DAYBED	136	Poltrone letto Armchair Bed
28	LETTO A RIBALTA APERTURA DA SCHIENALE FOLDING BED BACK OPENING Materasso 19 cm / Mattress 19 cm	154	Trasformabili Multifunctional Products
44	LETTO A RIBALTA APERTURA DA SCHIENALE FOLDING BED BACK OPENING Materasso da 12 cm a 16 cm / Mattress from 12 cm to 16 cm	198	Vico Collection
90	LETTO A RIBALTA APERTURA DA SEDUTA FOLDING BED SEAT OPENING	221	Steven Guarnaccia
102	LETTO ESTRAIBILE / PULL-OUT BED	222	Schede tecniche Technical Sheets

ABC	20	Cy	48
Acca	140	Dadà	122
Amour	30	Dandy	124
Aoy	92	Di-Tra-Verso	118
Babu	146	Dudù	130
Bibi	142	Express	206
Big-Bag	22	Fefè	106
Bitta	158	Flower	94
Brando	160	Gilbert & George	166
Broomstick Uno	204	Giù	96
Bye	104	Go	50
Canispè	164	Go.up	32
Ciac	46	Ho	52
Country.club	134	Holi	34
Commedia	24	Iboo	54
		Ipno	168
		Istante	126
		Kai	170
		Lazy Basketball	172

Le Temps de la Communauté		Pit	38
Lowe	174	Plan	64
Maracanà	36	Q.letto	186
Matrix	176	Quilt	66
Mehari	56	Ritz	70
Micia	178	Saiwa	74
Moby	148	Siesta	188
Moma	182	Sky	110
Nuvò	208	Snob	42
O.scià	26	Soft	76
Oa	98	Tango	78
Oblò	100	Tip-Tap	82
Olo	210	Tutù	190
Oops	108	Underdog	192
Ospite	150	Virgola	152
Piazzagrande	214	Yaki	194
Piccy	60	Zazà	86
Pisola	218	Zoe	144
	184	Zoom	196

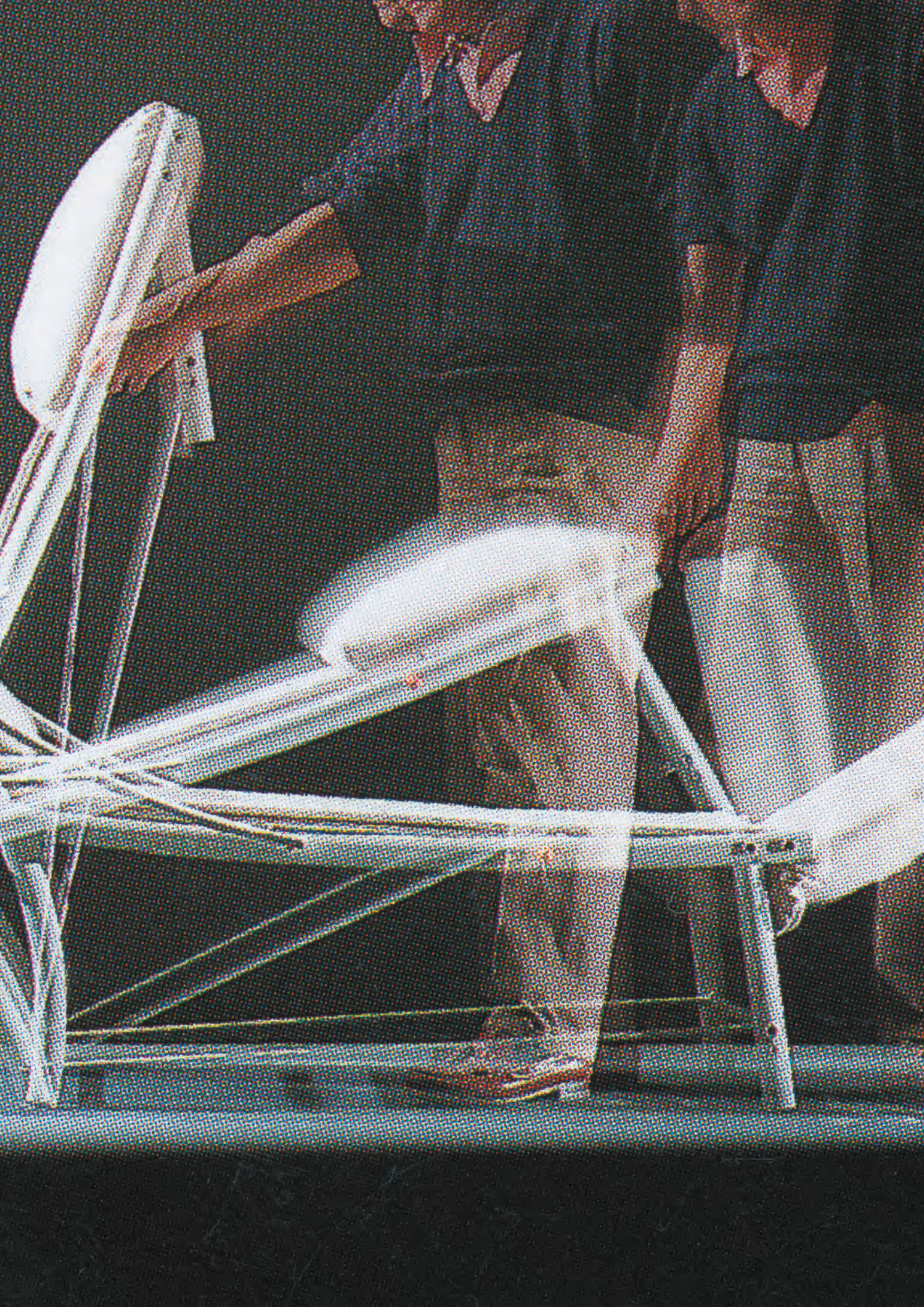

Per evitare la noia delle posizioni acquisite, per superare l'immobilità delle situazioni sedimentate, per rimettere in moto desideri e piaceri, Campeggi immagina un universo luminoso e dinamico di arredi trasformabili pronti a muoversi e cambiare per assecondare il piacere dell'abitare, del vivere e del cambiare. Per accelerare prima dello sbadiglio, Campeggi propone il proprio dizionario fatto di Comodità, Agilità, Movimento, Pragmaticità, Economicità, Grazia, Gioco, Imprevedibilità. La Comodità ovvero l'uso di materiali tecnologicamente avanzati e frutto di studi ergonomici d'avanguardia; l'Agilità fisica ma anche mentale di ogni pezzo della collezione; il Movimento come regola base che permette la trasformabilità di ogni progetto; la Pragmaticità figlia di una tradizione aziendale che pur sognando e inseguendo immaginari inediti non si spinge in voli pindarici su territori impraticabili; l'Economicità come primo obiettivo; la Grazia della misura, dell'equilibrio e della sobrietà, date dalla collaborazione stretta e complice con i migliori progettisti internazionali; il Gioco come piacere preso seriamente, certi dell'importanza del sorriso; l'Imprevedibilità come logica conseguenza di una filosofia aziendale che non pratica l'ovvio e mai si adagia sulle posizioni acquisite. Un dizionario come un catalogo, quindi, costantemente arricchito di anticonformismo, freschezza, humour, invenzione e leggerezza. Gli arredi trasformabili delle collezioni Campeggi danno vita a un volume che, anche in futuro, costituirà con evidenza il riferimento per chi cercherà nell'arredamento innovazione tecno-tipologica e non banalità, lievità e non lusso, intelligenza dinamica e non statica immobilità. L'immobilità evita il dialogo e non registra gli eventi nel mondo intorno a noi. Le cose che non cambiano sono destinate a inaridirsi, solo quelle in grado di cambiare non muoiono. Campeggi, sempre fedele a sé stessa, continua a cambiare per voi.

In order to avoid boredom of acquired positions, to overcome stillness of static situations, to restart desires and pleasures, Campeggi is imagining a bright and dynamic universe full of objects ready to be moved or transformed in order to comply with your pleasure of dwelling, living and changing. To speed up before a yawn, Campeggi is proposing you its own dictionary made of Comfort, Agility, Movement, Practicalness, Economy, Gracefulness, Game and always Inexhaustible. Comfort, namely the use of technologically advanced materials; the results of ergonomic and updated researches; Agility, physically but also mentally speaking of each single piece of the collection; Movement as a fundamental rule which allows a transformability of every single project; Practicalness as the result of a corporate tradition which, while dreaming and following new imaginaries, does not venture in "Pindaric flights" within impractical territories; Economy as the first target; Gracefulness of measure, balance and sobriety, resulting from the strict and knowing co-operation with the best international designers; Game as a serious pleasure, sure of the importance given by a smile; Inexhaustible as a logic consequence of a corporate thinking which does not put into practice what is obvious and which never sinks into acquired positions. A dictionary as a catalogue, therefore, constantly enriched with unconventionality, freshness, humour, innovation, and lightness. Objects of the Campeggi's collection give birth to a catalogue that in the future years will form, with evidence, a point of reference for those in search of a tech-typological innovation and not banality, faintness, luxury, but dynamic intelligence and not static stillness. Stillness prevents and does not register event in the near world. Things that are not changing are bound to dry up; just those that can face a change do not die. Campeggi, always faithful to itself, is still changing for you.

1959

Nasce la Campeggi Luigi — Poltrone e Divani

Campeggi Luigi — Poltrone e Divani is founded



1968

Tavoletto — Salvati Tresoldi

1968 XIV Triennale di Milano
1972 The Museum of Modern Art, New York:
Italy: The New Domestic Landscape
2005 Fondazione AQ per il Design:
100 Esemplari al Top Italian Beauty



1972

Tavoletto — Salvati Tresoldi The Museum of Modern Art, New York, Collezione permanente

The Museum of Modern Art,
New York, Permanent collection

1973

Logo e Logotipo progettati Unimark International

Logo and Logotype designed
by Unimark International

1985

Identità grafica e layout cataloghi disegnati da Italo Lupi con Steven Guarnaccia

Graphic identity and catalog layout designed
by Italo Lupi with Steven Guarnaccia



1989

Trans — Denis Santachiara

1990 Creativitalia: The joy
of Italian design

1996

Ospite — Vico Magistretti

2002 Vitra Design Stiftung GmbH:
Living in Motion
2003 Fond National d'Art
Contemporain, Puteaux
2008 El Museo Nacional de Bellas
Artes, Buenos Aires
2023 Museum of Art Pudong, Shanghai:
Design for Fun

1996

Pisolò — Denis Santachiara

1997 Fond National d'Art
Contemporain, Puteaux
1999 Centre George Pompidou, Parigi
2001 Grimaldi Forum, Principato
di Monaco: Air Air
2001 Design come stili di vita. 10 paesaggi
italiani, Yokohama, Giappone
2001 Vitra Design Museum, Basel: Blow Up
2002 Ecopremio Packaging Comeico
2003 Triennale di Milano: Design in Italy
2003 Triennale di Milano: Milano,
la Triennale e la Città infinita
2003 Institut de Cultura de Barcelona Alehop!
2003 Triennale di Milano: Maestri
2008 2a Bienal Brasileira de Design
2008 Pop Design Caraglio
2009 Triennale Design Museum



1999

Xito — Giovanni Levanti

2001 XIX Compasso d'Oro, Menzione d'onore
2006 The Montreal Museum of Fine Arts:
Il Modo Italiano
2006 ADI: 50 anni di Compasso d'Oro
Selezionato
2007 MART (Museo di Arte Moderna
e Contemporanea di Trento e Rovereto)
2007 Palermo Design Week 2007
2008 2a Bienal Brasileira de Design
2012 Domus Academy: Lost in Translation



2000

Estesa — Vico Magistretti

2003 Institut de Cultura de Barcelona Alehop!
2003 Fond National d'Art
Contemporain, Puteaux

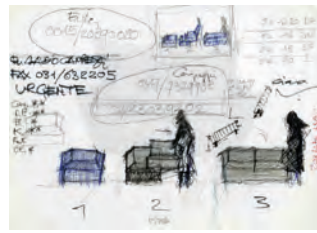

2000

Africa — Vico Magistretti

2003 Fond National d'Art
Contemporain, Puteaux
2003 Triennale di Milano: Milano,
la Triennale e la Città infinita

2001

Marocchino — Denis Santachiara

2006 Triennale di Milano:
Fumetto International
2007 Triennale di Milano, 100 oggetti
2008 Goal! A parade of Contemporary
Italian Design, Mumbai
2008 Goal! A parade of Contemporary
Italian Design, Istanbul
Pop Design Caraglio
2013 Mostra Cesare Cattaneo:
Pensiero e Segno nell'Architettura
2013 Dimore Design 2013, Bergamo



2001

Xito — Giovanni Levanti Triennale di Milano, Collezione permanente

Triennale di Milano, Permanent Collection

2003

Kenia — Vico Magistretti Triennale di Milano, Collezione permanente

Triennale di Milano, Permanent Collection

2003

Palazzo Ducale, Genova: Vico Magistretti, il design dagli anni '50 ad oggi

Palazzo Ducale, Genoa: Vico Magistretti,
Design from the 1950s to Today



2005

Airpouf — Lorenzo Damiani

2005 Art of Italian Design, Atene
2007 Milano Made in Design
2009 Triennale di Milano: Ma dove sono finiti
gli inventori? Lorenzo Damiani
2009 Cité du Design, Saint Etienne
2013 Biennale Internationale Design,
Saint Etienne: Vous voulez rire?

2006

Ercolino — Giulio Manzoni

2006 24° cDIM, Design



2007

Coppi — Denis Santachiara

2010 Serpentine Gallery's 10th Anniversary
Pavilion by Jean Nouvel, London



2007

Ori.Tami — Giulio Manzoni

- 2008 Goal! A parade of Contemporary Italian Design, Mumbai
- 2008 Goal! A parade of Contemporary Italian Design, Istanbul



2009

Airtable — Lorenzo Damiani

- 2009 Triennale di Milano: Ma dove sono finiti gli inventori? Lorenzo Damiani



2009

50 anni dalla fondazione dell'azienda

50 years since Campeggi was established



2010

T-Chair — Lorenzo Damiani Vitra Design Museum Collection



2010

Chambre d'Ami — Matali Crasset

- 2010 Elle Decoration International Design Award China 1° classificato
- 2011 Triennale Design Museum IV edizione: Le fabbriche dei sogni

132



2011

Sosia — Emanuele Magini

- 2006 Triennale di Milano: Fumetto International
- 2007 Triennale di Milano, 100 oggetti
- 2008 Goal! A parade of Contemporary Italian Design, Mumbai
- 2008 Goal! A parade of Contemporary Italian Design, Istanbul
- 2008 Pop Design Caraglio
- 2013 Mostra Cesare Cattaneo: Pensiero e Segno nell'Architettura
- 2013 Dimore Design 2013, Bergamo

132

132



2011

XXII Compasso d'Oro Menzione d'onore Ricerca d'Impresa "Trasformazione e Innovazione"

- XXII Compasso d'Oro Honorable Mention, Corporate Research
- "Transformation and Innovation"

132

2013

Premio Nazionale per l'innovazione, V Edizione 2013 — Patrocinato dal Presidente della Repubblica Italiana
National Innovation Award, 5th Edition 2013
Under the Patronage of the President of the Italian Republic



2016

XXIV Compasso d'Oro Menzione d'onore Family

- XXIV Compasso d'Oro Honorable Mention, Family Category



2017

Ried. Piccy — Vico Magistretti

- 2023 "Design for Fun" Museum of Art Pudong, Shanghai

132

2019

58° Salone Internazionale del Mobile Attestato per 50 anni di ininterrotta partecipazione a Salone Internazionale del Mobile

- Certificate of the 58th Salone Internazionale del Mobile for 50 years of uninterrupted participation

2021

Triennale di Milano: Vico Magistretti Architetto milanese



2022

Extension de Générosité — Matali Crasset Vitra Design Museum Collection

132

2023

Logotipo progettato da Superness (Alessio D'Ellena)

- Logotype by Superness (Alessio D'Ellena)

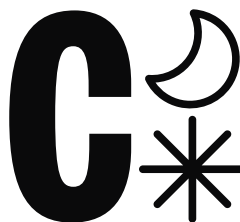

2023

Clo — Emanuele Magini

- 2023 Big See Design Award

2023

Ippo — Finemateria

- 2023 Good Design Award

132



2024

BIM Milano: Salone Calmo. A Showcase of Campeggi Objects

2024

Brando — Giuseppe Arezzi

- 2024 "Brando nel Microlocale" Small Small Space, Milano
- 2025 IDEAT Design Awards, "Best Chaise Longue of The Year"

132



2025

Suppergiù 60 sedie in 60 anni. Fondazione Vico Magistretti, Milano

2025

Vico e Campeggi alla Torre. Torre al Parco, Milano

132



2025

"Tutto già c'è, è solo un po' nascosto"

132

1959

Campeggi nasce a Giussano, frutto dell'intuizione di Luigi Campeggi. Azienda storica, tra le prime al mondo a produrre trasformabili e leader nella progettazione di divani e divani letto. Dal 1959 reinterpreta il concetto di arredamento, fondendo tradizione Made in Italy con una continua sperimentazione.

Design Made in Italy

La mission di Campeggi è un design colto e intelligente. I divani e gli imbottiti Campeggi non sono solo mobili, sono soluzioni. Creazioni di manifattura artigianale Made in Italy, progettate per essere accessibili e per durare nel tempo. Ogni pezzo è realizzato per rispondere alle esigenze del vivere moderno, dove comfort e funzionalità si intrecciano.

Riconoscimento Globale

Campeggi non è solo un nome, è un simbolo. I suoi prodotti fanno parte di prestigiose collezioni di musei internazionali, dal MoMA di New York alla Triennale di Milano fino al Vitra Design Museum a Weil am Rhein. Una testimonianza del suo contributo al design contemporaneo.

Designer

Campeggi collabora con designer e figure creative di fama internazionale, tra cui Vico Magistretti e Italo Lupi. L'azienda è alla costante ricerca di nuove figure nel panorama del design; il dialogo con i creativi emergenti rende Campeggi un'azienda contemporanea, con lo sguardo rivolto al futuro.

Sperimentazione

L'identità aziendale si fonda su innovazione e sperimentazione. Con meccanismi avanzati e soluzioni all'avanguardia, Campeggi crea oggetti che ridefiniscono gli spazi, rispondendo alle sfide del quotidiano. Nel 1968, il trasformabile ha preso forma: un oggetto ibrido multifunzionale che offre soluzioni diverse, dimostrando che il design può essere versatile e creativo.

Showroom

Nel 2010 l'architetto parmense Guido Canali progetta 800 m2 di showroom nell'headquarter aziendale in Brianza, vicino al lago di Como. Uno spazio multifunzionale, metafora dei prodotti Campeggi: a seconda delle necessità, lo spazio cambia e si trasforma. È allo stesso tempo showroom commerciale, museo aziendale, exhibition space e spazio per uffici.

1959

Campeggi was founded in Giussano, the result of Luigi Campeggi's intuition. A historic company, among the first in the world to produce multifunctional furniture and leader in the design of sofas and sofa beds. Since 1959, it has reinterpreted the concept of furnishing, merging the tradition of Made in Italy with continuous experimentation.

Design Made in Italy

Campeggi's goal is a sophisticated design. The sofas are not just pieces of furniture, they are solutions. Creations of artisanal craftsmanship, Made in Italy, designed to be accessible and ensure durability over time. Each piece is crafted to meet the needs of modern living, where comfort and functionality intertwine.

Global recognition

Campeggi is not just a name, it is a symbol. Its products are part of prestigious collections in international museums: MoMA in New York, the Triennale di Milano, and the Vitra Design Museum in Weil am Rhein. This is evidence of its contribution to contemporary design.

Designers

Campeggi collaborates with internationally renowned designers and creative figures, including Vico Magistretti and Italo Lupi. The company is also constantly in search of new talents in the design field, allowing for exploration of various contemporary perspectives while following with industry evolutions.

Experimentation

Its identity is rooted in innovation and experimentation. With advanced mechanisms and innovative solutions, Campeggi creates objects that redefine spaces, addressing everyday challenges. In 1968, the transformable concept took shape: a hybrid multifunctional object that offers different solutions, demonstrating that design can be versatile and creative.

Showroom

In 2010 architect Guido Canali from Parma designed the 800 m2 Campeggi showroom at the company's headquarters in Brianza, near Lake Como. A multifunctional space, a true metaphor for Campeggi products: the space changes and transforms according to needs. It serves simultaneously as a commercial showroom, corporate museum, exhibition space, and office area.







Divani e Divani Letto

Sofa and Sofa Bed

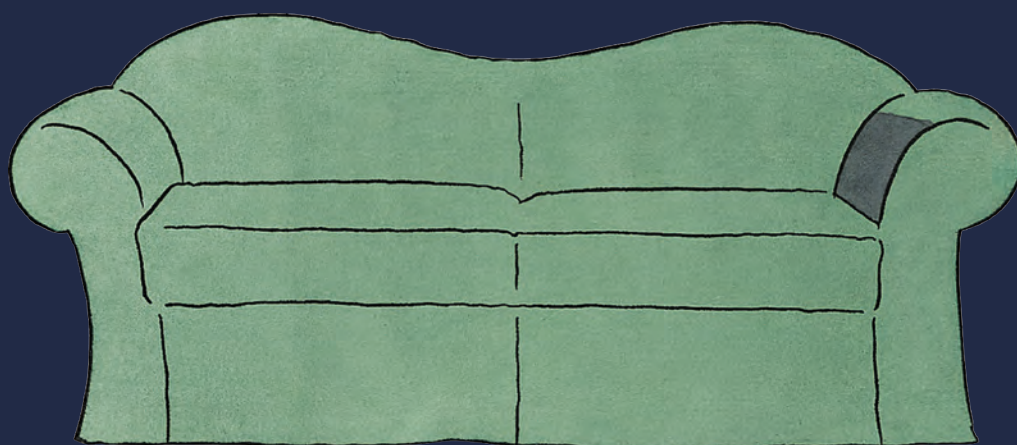

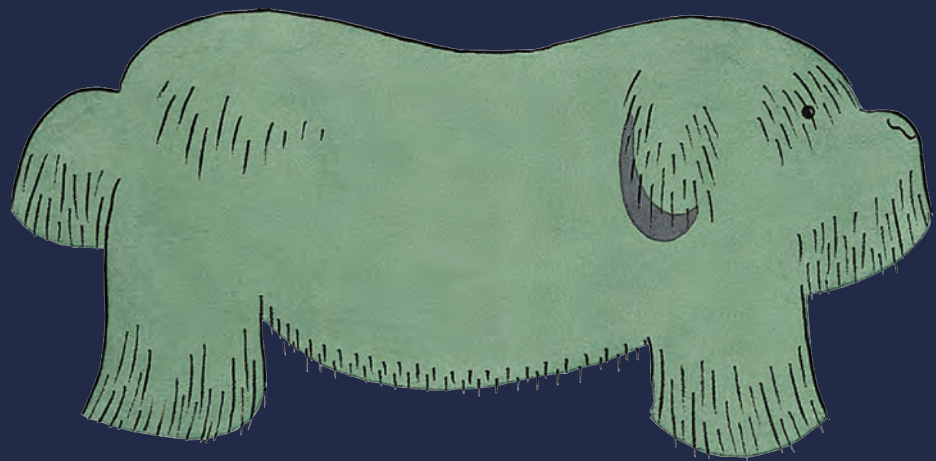

Divani e Divani Letto

Sofa and Sofa Bed

DAYBED

ABC

20 Big-Bag

22



Commedia

24 Nuvò

26



LETTO A RIBALTA APERTURA DA SCHIENALE
FOLDING BED BACK OPENING

Materasso 19 cm / Mattress 19 cm

Amour

30 Go.Up

32



Holi

34 Lowe

36 Pit

38



Snob

42



Divani e Divani Letto

Sofa and Sofa Bed

LETTO A RIBALTA APERTURA DA SCHIENALE
FOLDING BED BACK OPENING

Materasso da 12 cm a 16 cm /
Mattress from 12 cm to 16 cm

Ciac

46 **Cy**

48



Go

50 **Ho**

52 **Iboo**

54



Matrix

56 **Piazzagrande**

60 **Plan**

64



Quilt

66 **Ritz**

70 **Saiwa**

74



Soft

76 **Tango**

78 **Tip-Tap**

82



Zazà

86



Divani e Divani Letto

Sofa and Sofa Bed

LETTO A RIBALTA APERTURA DA SEDUTA
FOLDING BED SEAT OPENING

Aoy



92 Flower



94

Giù



96 O.scia



98 Oa



100

LETTO ESTRAIBILE
PULL-OUT BED

Bye



104 Fefè



106

Olo



108 Sky Uno



110 Sky Due



112

Sky Tre



114

Divani e Divani Letto

Sofa and Sofa Bed

**LETTO TRASVERSALE
TRANSVERSE BED**

Di-Tra-Verso

118



**PRONTO LETTO AD ALZATA FRONTALE
READY-TO-USE BED WITH FRONT LIFT**

Dadà

122

Dandy

124



Istante

126



**LETTO A LIBRO - MECCANISMO A PETTINE
BOOK-STYLE BED - COMB MECHANISM**

Dudù

130

Oblò

210



**DIVANO
SOFA**

Country.club

134

Express

206



Daybed

ABC

20 **Big-Bag**

22 **Commedia**

24



Nuvò

26



ABC

DESIGNER GIULIO MANZONI

SCHEDA TECNICA / TECHNICAL SHEET 226

A-ccogliente, B-ello, C-omodo, proprio come ogni salotto dovrebbe essere. Con semplici gesti, questo divano si trasforma in una camera da letto singola, matrimoniale o con due letti gemelli. E, quando il grande schienale si apre, svela una tasca porta guanciali che diventa comodo cuscino poggiareni. Disegnato per molteplici configurazioni e differenti utilizzi, ABC è disponibile nella versione con bracciolo destro o sinistro per un sistema relax privo di qualunque struttura metallica. ABC: un divano letto facile ed elementare come l'alfabeto.

A-ccommodating, B-eautiful, C-omfortable, just as every living room should be. With a few simple gestures, this sofa transforms into a single bed, a double bed, or twin beds. And when the large backrest opens, it reveals a pillow pocket that becomes a comfortable lumbar cushion. Designed for multiple configurations and different uses, ABC is available with either a right or left armrest, offering a relaxing system completely free of any metal structure. ABC: a sofa bed as easy and essential as the alphabet.

ALTEZZA MATERASSO / MATTRESS HEIGHT

8 cm

DIVANO ANGOLARE TRASFORMABILE IN LETTO SINGOLO / CORNER SOFA WITH SINGLE BED

Letto / Bed 82x200 cm

DIVANO ANGOLARE TRASFORMABILE IN LETTO MATRIMONIALE / CORNER SOFA WITH DOUBLE BED

Letto / Bed 164x200 cm



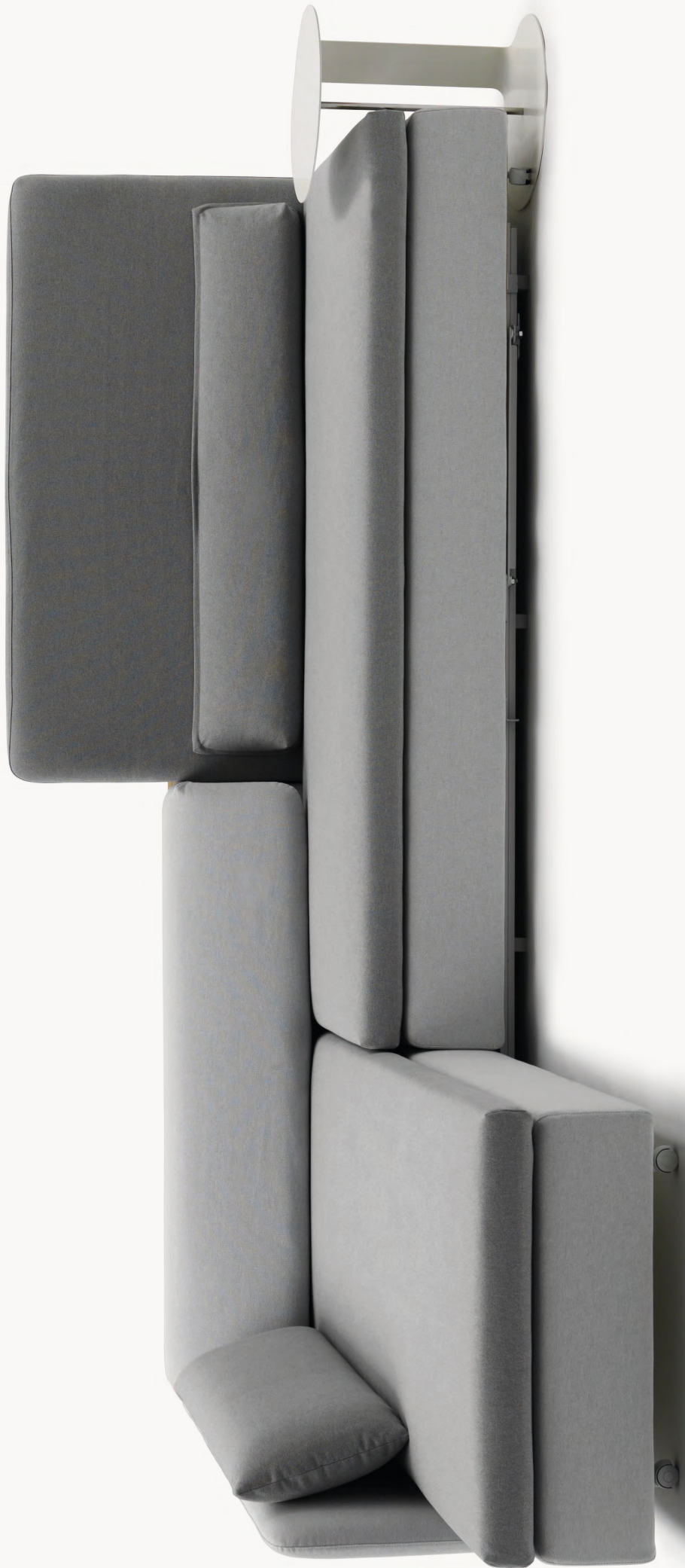

Big-Bag

DESIGNER GIULIO MANZONI

SCHEDA TECNICA / TECHNICAL SHEET 231

Big-Bag è un divano letto che può essere riconfigurato a piacere grazie allo schienale formato da cuscini autoportanti, con pratica maniglia in cuoio, appoggiati sul piano di seduta e opportunamente bilanciati per offrire il giusto sostegno. Nessuna complicazione, massima libertà di fruizione: un divano letto singolo sempre a disposizione. All'occorrenza, si può trasformare in una grande isola o un comodo letto matrimoniale.

Big-Bag is a sofa you can reconfigure and reinvent according to your fancy, thanks to its backrest consisting of self-supporting cushions, with a practical leather handle, simply laying on the seating surface and appropriately balanced to provide the right support. No complications, maximum freedom of use: a sofa and a single bed always at your disposal. If needed, you can obtain a large island or a comfortable double bed.

ALTEZZA MATERASSO / MATTRESS HEIGHT

14 cm

DIVANO LETTO SINGOLO / SINGLE SOFA BED

Letto / Bed 112x200 cm

DIVANO LETTO MATRIMONIALE / SUPER KING SIZE SOFA BED

Letto / Bed 193x185 cm





Commedia

DESIGNER JULIE RICHZOZ

SCHEDA TECNICA / TECHNICAL SHEET 235

Commedia è un palcoscenico della quotidianità. La coperta non è un accessorio, ma la protagonista: avvolge, trasforma, accoglie. Si stende sull'imbottito in un morbido strato di lana, pronta a diventare letto per un ospite inatteso. La sua forma è familiare ma dinamica, un collage di elementi diversi: legno, braccioli scolpiti, materasso, coperta e cuscini che dialogano tra loro in un equilibrio di leggerezza, comfort e modularità.

Commedia is a stage for everyday life. The blanket isn't an accessory but the main character it wraps, transforms, embraces. Draped in a soft layer of wool, it's ready to turn the sofa into a bed for an unexpected guest. Its shape is familiar yet dynamic: a collage of elements, from wood and sculpted armrests to mattress, blanket and cushions all in dialogue, balancing lightness, comfort and modularity.

ALTEZZA MATERASSO / MATTRESS HEIGHT

14 cm

DIVANO LETTO SINGOLO / SMALL SINGLE SOFA BED

Letto / Bed 80x200 cm

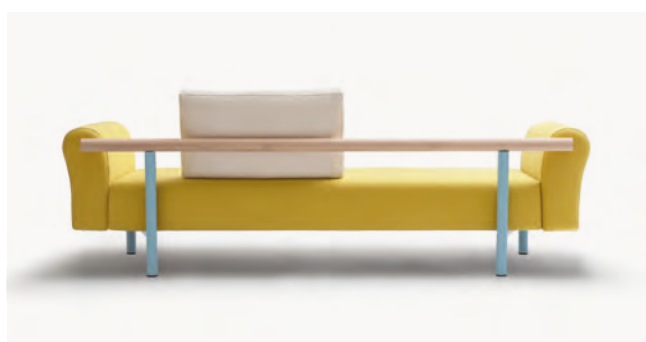



Nuvò

DESIGNER PAOLO IMPERATORI

SCHEDA TECNICA / TECHNICAL SHEET 254

Ecco il divano trasformabile nella sua forma più astratta, la cui essenzialità è esaltata dalla mancanza di meccanismi complessi. I due cuscini cilindrici, citazione e riedizione dei *traversin* tipici dei letti alla francese, governano la configurazione diurna di seduta con piccolo schienale o quella notturna di letto singolo con testiera e pediera morbide. La struttura in acciaio è disponibile nelle finiture bianca o nera. Nuvò è un divano letto di cui è fin troppo facile innamorarsi.

Here is the convertible sofa in its most abstract form, whose essential character is enhanced by the absence of complex mechanisms. The two cylindrical cushions, a reference to and reinterpretation of the *traversins* typical of French-style beds, define the daytime seating configuration with a small backrest or the nighttime single-bed version with soft headboard and footboard. The steel frame is available in white or black finishes. Nuvò is a sofa bed that is all too easy to fall in love with.

ALTEZZA MATERASSO / MATTRESS HEIGHT

18 cm

DIVANO LETTO SINGOLO / SMALL SINGLE SOFA BED

Letto / Bed 92x202 cm

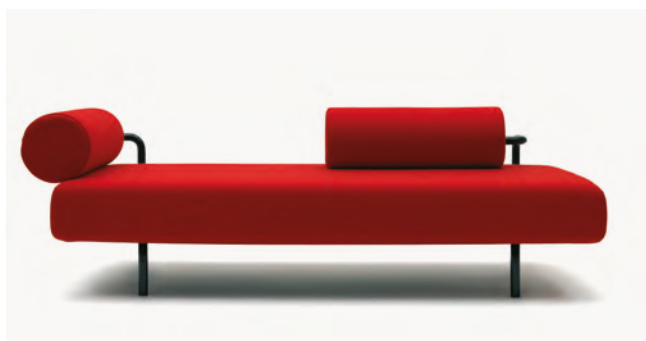

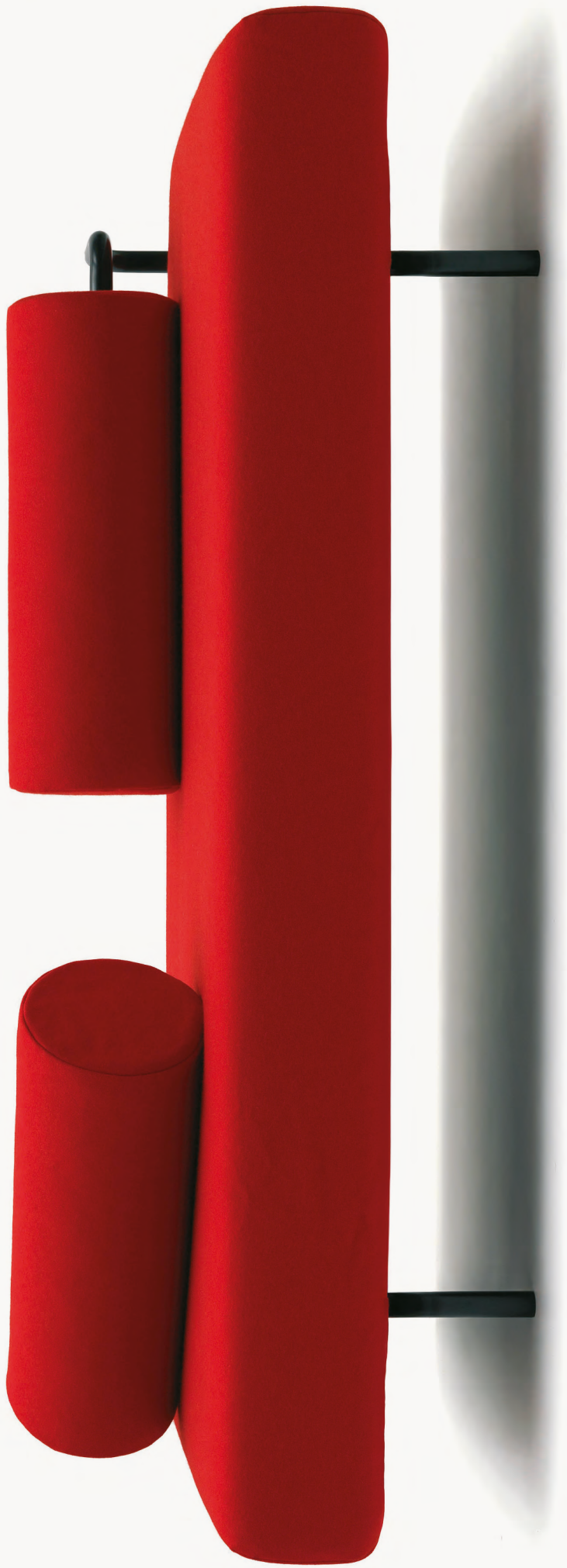

Letto a ribalta apertura da schienale Folding bed back opening

Materasso 19 cm / Mattress 19 cm

Amour



30 **Go.Up**



32 **Holi**



34

Lowe



36 **Pit**



38 **Snob**



42

Amour

DESIGNER CAMPEGGI DESIGN

SCHEDA TECNICA / TECHNICAL SHEET 227

Disponibile nelle versioni due posti, tre posti e tre posti maxi, Amour è un divano compatto che unisce semplicità e carattere, ispirato alla tipologia del divano *a pozzetto*. Le linee pulite e arrotondate, insieme ai poggiatesta removibili, richiamano uno stile classico e accogliente. Nella versione divano letto, Amour è dotato di un materasso h cm 19 e di una struttura di supporto con doghe larghe in faggio stratificato anti-affossamento, per un riposo confortevole e di qualità.

Available in two-seater, three-seater and three-seater maxi versions, Amour is a compact sofa that combines simplicity and character, inspired by the sofa *a pozzetto* typology. Clean, rounded lines and removable headrests recall a classic, welcoming style. In the sofa bed version, Amour features a 19 cm-thick mattress and a support structure with wide laminated beech wood slats designed to prevent sagging, ensuring comfortable, high-quality rest.

ALTEZZA MATERASSO / MATTRESS HEIGHT

19 cm (materasso a molle / spring mattress)

19 cm (materasso in poliuretano / polyurethane mattress)

19 cm (materasso in memory foam / memory foam mattress)

DIVANO LETTO PIAZZA E MEZZA / SMALL DOUBLE SIZE SOFA BED

DIVANO LETTO MATRIMONIALE PICCOLO / DOUBLE SIZE SOFA BED

DIVANO LETTO MATRIMONIALE GRANDE / KING SIZE SOFA BED

Letto / Bed 115x200 cm

Letto / Bed 140x200 cm

Letto / Bed 160x200 cm

ALTRE CONFIGURAZIONI / OTHER CONFIGURATIONS

Disponibile in versione fissa / Available sofa without bed





Go.Up

DESIGNER CAMPEGGI DESIGN

SCHEDA TECNICA / TECHNICAL SHEET 244

La famiglia di divani Go, protagonista di un'importante innovazione nel mondo dei trasformabili grazie al meccanismo di estrazione semplificato con letto subito pronto, si arricchisce con Go.up. Disponibile nelle versioni due posti, tre posti e tre posti maxi, questo divano letto di design si distingue per la solidità della struttura e la versatilità stilistica. È dotato di un materasso alto 19 cm e di un piano di riposo con doghe larghe in faggio stratificato anti-affossamento, per un comfort di qualità.

The Go sofa family, known for introducing a major innovation in the world of convertible sofas with its simplified pull-out mechanism and instantly ready bed, is now joined by Go.up. Available in two-seater, three-seater, and three-seater maxi versions, this design sofa bed stands out for its solid structure and stylistic versatility. It features a 19 cm-thick mattress and a sleeping surface with wide laminated beech wood slats designed to prevent sagging, ensuring high-quality comfort.

ALTEZZA MATERASSO / MATTRESS HEIGHT

19 cm (materasso a molle / spring mattress)
19 cm (materasso in poliuretano / polyurethane mattress)
19 cm (materasso in memory foam / memory foam mattress)

DIVANO LETTO PIAZZA E MEZZA / SMALL DOUBLE SIZE SOFA BED
DIVANO LETTO MATRIMONIALE PICCOLO / DOUBLE SIZE SOFA BED
DIVANO LETTO MATRIMONIALE GRANDE / KING SIZE SOFA BED

Letto / Bed 115x200 cm

Letto / Bed 140x200 cm

Letto / Bed 160x200 cm

ALTRE CONFIGURAZIONI / OTHER CONFIGURATIONS

Disponibile in versione fissa / Available sofa without bed



GO.UP

LARGHEZZA BRACCIOLO / ARMREST WIDTH 18 cm



GO.UP SMALL

LARGHEZZA BRACCIOLO / ARMREST WIDTH 8 cm



GO.UP SLIM

LARGHEZZA BRACCIOLO / ARMREST WIDTH 4 cm

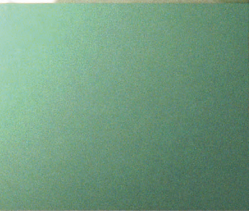
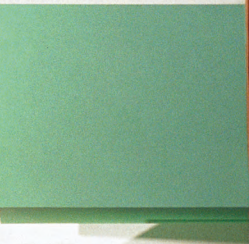
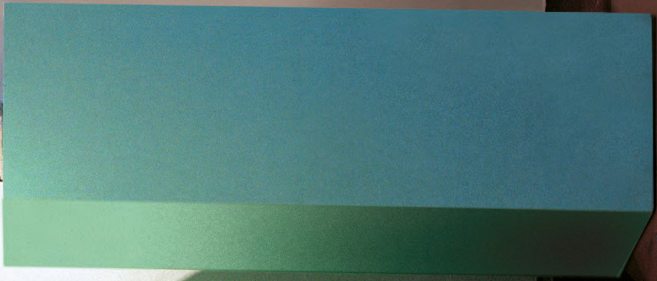

Holi

DESIGNER CAMPEGGI DESIGN

SCHEDA TECNICA / TECHNICAL SHEET 247

In questo divano tutti gli spigoli sono arrotondati, fondendo l'essenzialità delle linee rigorose con un carattere di morbidezza e accoglienza, apprezzabile sia nella vista frontale sia di profilo. Trasformabile da divano a letto con un semplice gesto, è dotato di una struttura in doghe larghe in faggio stratificato anti-affossamento e di un materasso alto 19 cm.

In this sofa, all edges are rounded, blending the essential rigor of clean lines with a sense of softness and welcome, appreciable both from the front view and in profile. It transforms from sofa to bed with a simple gesture, featuring a structure made of wide laminated beech wood slats designed to prevent sagging, and a 19 cm-thick mattress for enhanced comfort.

ALTEZZA MATERASSO / MATTRESS HEIGHT

19 cm (materasso a molle / spring mattress)
19 cm (materasso in poliuretano / polyurethane mattress)
19 cm (materasso in memory foam / memory foam mattress)

POLTRONA LETTO / CHAIR BED

DIVANO LETTO PIAZZA E MEZZA / SMALL DOUBLE SIZE SOFA BED

DIVANO LETTO MATRIMONIALE PICCOLO / DOUBLE SIZE SOFA BED

DIVANO LETTO MATRIMONIALE GRANDE / KING SIZE SOFA BED

Letto / Bed 75x200 cm
Letto / Bed 115x200 cm
Letto / Bed 140x200 cm
Letto / Bed 160x200 cm

ALTRE CONFIGURAZIONI / OTHER CONFIGURATIONS

Disponibile in versione fissa / Available sofa without bed

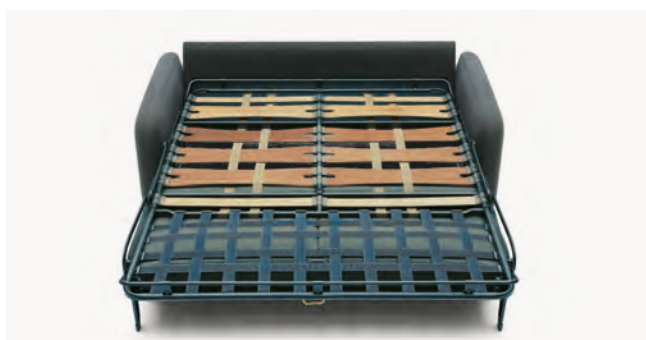

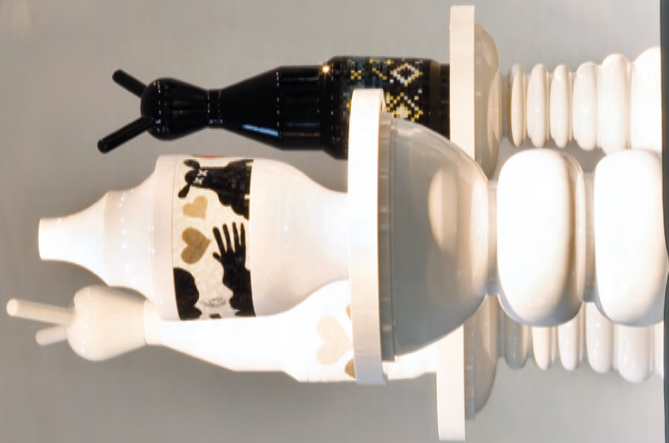
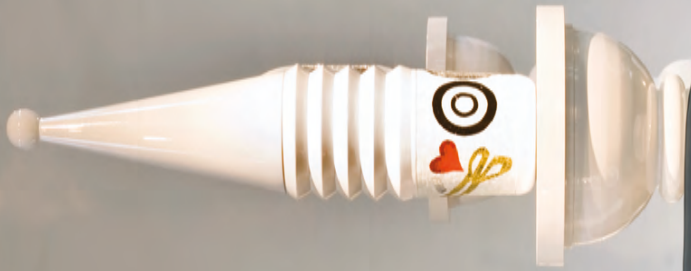

Lowe

DESIGNER CAMPEGGI DESIGN

SCHEDA TECNICA / TECHNICAL SHEET 251

Di linea squadrata ed essenziale, Lowe è un divano letto che esalta le forme basiche e accoglienti del divano contemporaneo e propone una configurazione innovativa che ottimizza lo spazio e consente l'impiego di un piano letto con proporzioni generose (materasso h cm 19), grazie ai braccioli ampi e comodi integrati nella struttura, con un piano di riposo dotato di doghe larghe in faggio stratificato anti-affossamento, per un comfort di qualità.

With a clean, squared design, Lowe is a sofa bed that enhances the simple, welcoming forms of contemporary seating and features an innovative configuration that optimises space while allowing the use of a generously proportioned sleeping surface (19 cm thick mattress). Wide, comfortable armrests integrated into the structure support a resting surface fitted with wide laminated beech slats with anti-sag properties, ensuring quality comfort.

ALTEZZA MATERASSO / MATTRESS HEIGHT

19 cm (materasso a molle / spring mattress)

19 cm (materasso in poliuretano / polyurethane mattress)

19 cm (materasso in memory foam / memory foam mattress)

DIVANO LETTO PIAZZA E MEZZA / SMALL DOUBLE SIZE SOFA BED

Letto / Bed 115x200 cm

DIVANO LETTO MATRIMONIALE PICCOLO / DOUBLE SIZE SOFA BED

Letto / Bed 140x200 cm

DIVANO LETTO MATRIMONIALE GRANDE / KING SIZE SOFA BED

Letto / Bed 160x200 cm

DIVANO LETTO MATRIMONIALE MEGA / SUPER KING SIZE SOFA BED

Letto / Bed 180x200 cm

ALTRE CONFIGURAZIONI / OTHER CONFIGURATIONS

Disponibile in versione fissa / Available sofa without bed

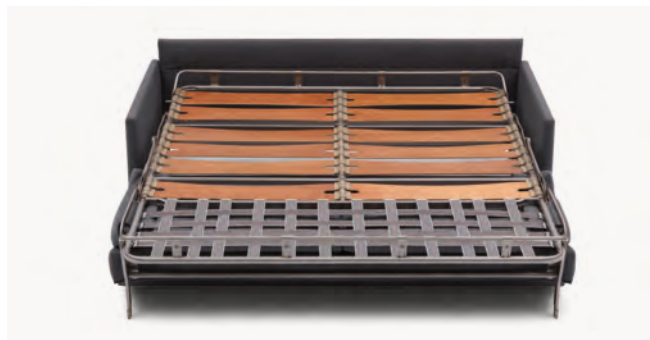



Pit

DESIGNER CAMPEGGI DESIGN

SCHEDA TECNICA / TECHNICAL SHEET 263

Pit è un divano elegante dalle forme semplici e accoglienti, valorizzato dalla finitura pizzicata che ne esalta la qualità. Disponibile con due braccioli o con chaise longue, arricchisce il living con uno stile esclusivo. Al suo interno nasconde un letto con materasso da 19 cm, offrendo un comfort paragonabile a quello di un vero letto. Con Pit, l'incontro tra zona giorno e notte diventa una soluzione raffinata e funzionale.

Pit is an elegant sofa with simple, inviting shapes, enhanced by its pinched stitching that highlights its quality. Available with two armrests or a practical chaise longue, it brings an exclusive touch to any living space. Inside, it conceals a bed with a 19 cm mattress, offering comfort comparable to that of a real bed. With Pit, the blend between living and sleeping areas becomes a refined and functional solution.

ALTEZZA MATERASSO / MATTRESS HEIGHT

19 cm (materasso in poliuretano / polyurethane mattress)

DIVANO LETTO MATRIMONIALE PICCOLO / DOUBLE SIZE SOFA BED DIVANO LETTO MATRIMONIALE GRANDE / KING SIZE SOFA BED

Letto / Bed 140x200 cm

Letto / Bed 160x200 cm

ALTRE CONFIGURAZIONI / OTHER CONFIGURATIONS

Disponibile in versione fissa / Available sofa without bed

Disponibile in versione angolare / Available modular sofa









Snob

DESIGNER CAMPEGGI DESIGN

SCHEDA TECNICA / TECHNICAL SHEET 271

Snob è un divano trasformabile che non ha bisogno di dichiarare i propri pregi: basta uno sguardo per coglierne l'accoglienza straordinaria, da vero primo della classe. Elegante nella sua configurazione da divano, sorprende per le prestazioni nella versione letto matrimoniale. Disponibile nelle versioni tre posti piccolo e tre posti grande, si adatta con facilità a spazi diversi. Al suo interno integra pratici vani porta guanciaie e un piano riposo in maglia d'acciaio, abbinato a un materasso in poliuretano espanso alto 19 cm, pensato per garantire un comfort reale e quotidiano.

Snob is a convertible sofa that doesn't need to boast about its qualities: a single glance is enough to sense its outstanding, first-class comfort. Refined in its sofa configuration, it delivers equally impressive performance as a bed. Available in small and large three-seater versions, Snob adapts easily to different spaces. Inside, it features practical pillow compartments, a steel mesh sleeping base, and a 19 cm thick polyurethane foam mattress, designed to ensure genuine, everyday comfort.

ALTEZZA MATERASSO / MATTRESS HEIGHT

19 cm (materasso in poliuretano / polyurethane mattress)

DIVANO LETTO MATRIMONIALE PICCOLO / DOUBLE SIZE SOFA BED

Letto / Bed 140x195 cm

DIVANO LETTO MATRIMONIALE GRANDE / KING SIZE SOFA BED

Letto / Bed 160x195 cm



SNOB

LARGHEZZA BRACCIOLO / ARMREST WIDTH 20 cm



SNOB SMALL

LARGHEZZA BRACCIOLO / ARMREST WIDTH 10 cm



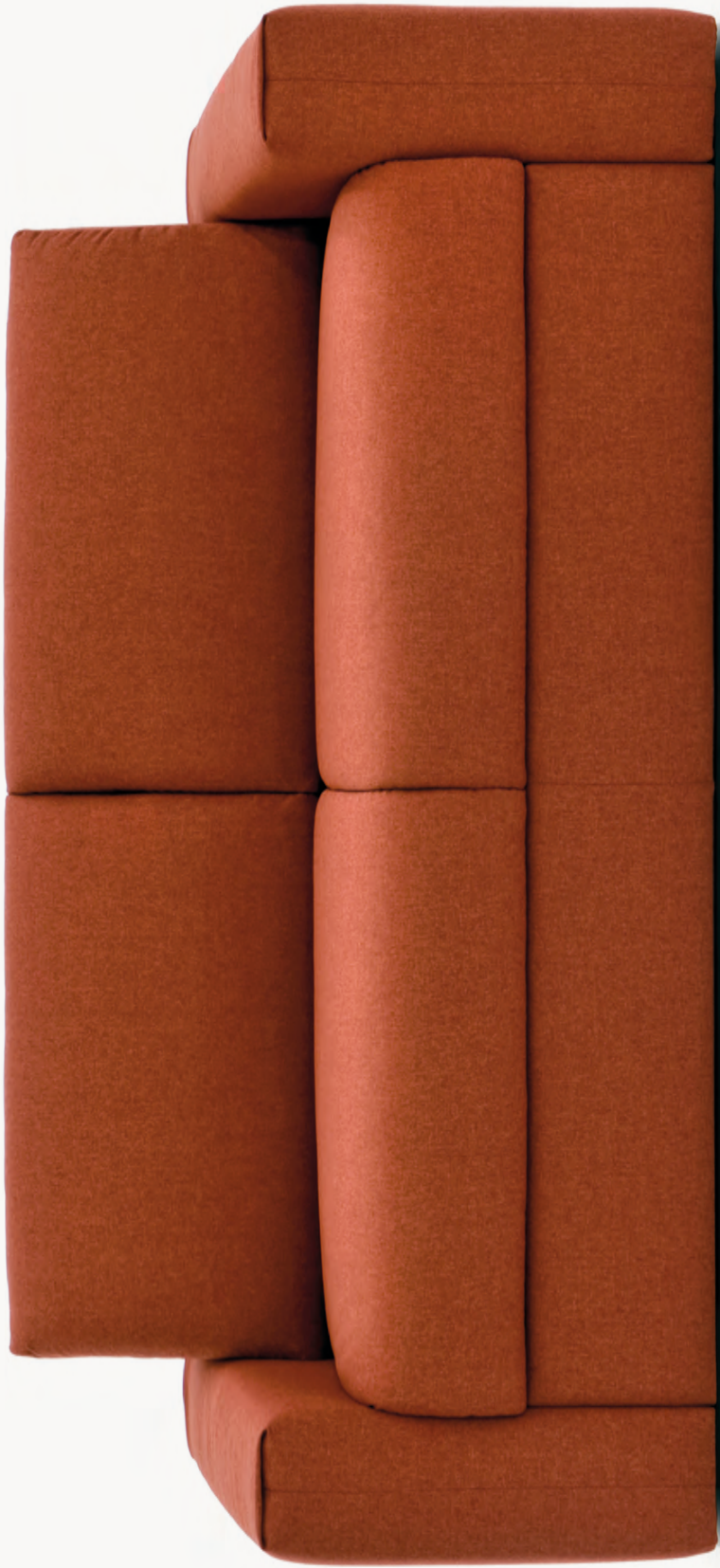

Letto a ribalta apertura da schienale Folding bed back opening

Materasso da 12 cm a 16 cm / Mattress from 12 cm to 16 cm

Ciac

46 Cy

48 Go

50



Ho

52 Iboo

54 Matrix

56



Piazzagrande

60 Plan

64 Quilt

66



Ritz

70 Saiwa

74 Soft

76



Tango

78 Tip-Tap

82 Zazà

86



Ciac

DESIGNER GIULIO MANZONI

SCHEDA TECNICA / TECHNICAL SHEET 234

Ciac unisce la purezza modernista al calore della pelle che riveste struttura e braccioli, in contrasto con la seduta imbottita. Piedini in acciaio brunito, rivestimento sfoderabile, realizzabile in vari tessuti e un letto sempre pronto con rete in maglia d'acciaio e materasso a molle rendono Ciac un divano elegante e funzionale.

Ciac combines modernist purity with the warmth of leather, which upholsters the structure and armrests, contrasting with the padded seat. Burnished steel feet, a fully removable cover, availability in a range of fabrics, and an always-ready bed with a steel mesh frame and spring mattress make Ciac an elegant and functional sofa.

ALTEZZA MATERASSO / MATTRESS HEIGHT

12 cm (materasso a molle / spring mattress)

12 cm (materasso in poliuretano / polyurethane mattress)

DIVANO LETTO MATRIMONIALE PICCOLO / DOUBLE SIZE SOFA BED DIVANO LETTO MATRIMONIALE GRANDE / KING SIZE SOFA BED

Letto / Bed 140x195 cm

Letto / Bed 160x195 cm





Cy

DESIGNER CAMPEGGI DESIGN

SCHEDA TECNICA / TECHNICAL SHEET 235

La plasticità classica aggiunta a un pizzico di tecnologia rende questo divano davvero semplice da trasformare in letto. Cy è un divano letto a due o tre posti, con una linea molto classica e modellata per essere accogliente sia di giorno che di notte. Nessun cuscino da rimuovere, trasformare Cy in letto è qualcosa di veramente elementare: basta spingere la spalliera in avanti. Disponibile anche nella versione tre posti maxi.

A classic model which beautifies and completes your home furnishing. Thanks to its classic sculptural quality, added to a bit of technology, it is really easy to transform this sofa into a bed. Cy may have 2 or 3 seats, and with its very classic and well-shaped line, it is comfortable both by day and by night. No cushion to remove, to transform Cy into a bed is very easy: you have just to push the back.

ALTEZZA MATERASSO / MATTRESS HEIGHT

14 cm (materasso a molle / spring mattress)

12 cm (materasso in poliuretano / polyurethane mattress)

DIVANO LETTO MATRIMONIALE PICCOLO / DOUBLE SIZE SOFA BED

Letto / Bed 140x200 cm

DIVANO LETTO MATRIMONIALE GRANDE / KING SIZE SOFA BED

Letto / Bed 160x200 cm



Edin
Cavdar
Balkan



1 VÖGEL
2 VÖGEL

HOHEN
BISFIC

HERO
X/14



Go

DESIGNER CAMPEGGI DESIGN

SCHEDA TECNICA / TECHNICAL SHEET 242

Un perfetto connubio tra tecnologia e design è quanto ci comunica Go, il nuovo divano letto dal movimento rivoluzionario. Un aspetto importante e la cuscineria ricca fanno di Go il trasformabile irripetibile. Un unico gesto soffice e garbato, permesso dal meccanismo tecnologicamente avanzato, trasforma Go nel letto definitivo per tutte le sere. La larghezza del suo bracciolo è personalizzabile.

A perfect blend of technology and design is embodied by Go, the new sofa bed with a revolutionary movement. Its distinctive look and generous cushioning make Go a one-of-a-kind convertible. With a single smooth and graceful gesture, enabled by its technologically advanced mechanism, Go turns into the ultimate bed for every night. The width of its armrest is customizable.

ALTEZZA MATERASSO / MATTRESS HEIGHT

14 cm (materasso a molle / spring mattress)

12 cm (materasso in poliuretano / polyurethane mattress)

POLTRONA LETTO / CHAIR BED

DIVANO LETTO PIAZZA E MEZZA / SMALL DOUBLE SIZE SOFA BED

DIVANO LETTO MATRIMONIALE PICCOLO / DOUBLE SIZE SOFA BED

DIVANO LETTO MATRIMONIALE GRANDE / KING SIZE SOFA BED

Letto / Bed 75x200 cm (Go Small e Go Slim / Go Small and Go Slim)

Letto / Bed 116x200 cm

Letto / Bed 140x200 cm

Letto / Bed 160x200 cm

ALTRE CONFIGURAZIONI / OTHER CONFIGURATIONS

Disponibile in versione fissa / Available sofa without bed



GO

LARGHEZZA BRACCIOLO / ARMREST WIDTH 18 cm



GO SMALL

LARGHEZZA BRACCIOLO / ARMREST WIDTH 8 cm

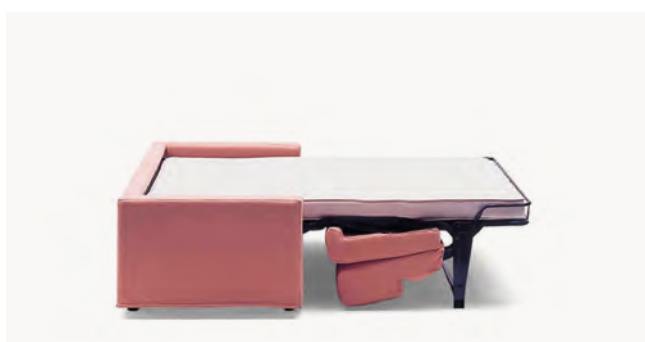

GO SLIM

LARGHEZZA BRACCIOLO / ARMREST WIDTH 4 cm



Ho

DESIGNER CAMPEGGI DESIGN

SCHEDA TECNICA / TECHNICAL SHEET 246

Un tempo il divano letto era un compromesso tra seduta e piano di riposo, con limiti di comfort e stile. Oggi, con modelli come Ho, queste funzioni si fondono armoniosamente: la forma essenziale, con seduta profonda e schienale continuo, garantisce eleganza, mentre il meccanismo di estrazione e la testata che si forma assicurano praticità e comfort.

There was a time when sofa beds were a compromise between seating and sleeping, often lacking in comfort and style. Today, with models like Ho, the two functions merge seamlessly: the clean design with a deep seat and continuous backrest ensures elegance, while the smooth opening mechanism and the headboard that forms provide practicality and comfort.

ALTEZZA MATERASSO / MATTRESS HEIGHT

12 cm (materasso in poliuretano / polyurethane mattress)

POLTRONA LETTO / CHAIR BED

Letto / Bed 70x195 cm

DIVANO LETTO PIAZZA E MEZZA / SMALL DOUBLE SIZE SOFA BED

Letto / Bed 120x195 cm

DIVANO LETTO MATRIMONIALE PICCOLO / DOUBLE SIZE SOFA BED

Letto / Bed 140x195 cm

DIVANO LETTO MATRIMONIALE GRANDE / KING SIZE SOFA BED

Letto / Bed 160x195 cm

ALTRE CONFIGURAZIONI / OTHER CONFIGURATIONS

Disponibile in versione fissa / Available sofa without bed



SENZA BRACCIOLI / WITHOUT ARMRESTS



BRACCIOLO / ARMREST 102 cm



BRACCIOLO LUNGO / LONG ARMREST 185 cm



Iboo

DESIGNER CAMPEGGI DESIGN

SCHEDA TECNICA / TECHNICAL SHEET 248

Iboo è un divano trasformabile che punta alla nitidezza della linea e alla compattezza della forma. Rigore e comfort ne completano l'immagine, rendendolo attuale ed equilibrato. Iboo è un vero divano ma anche un vero letto: lo dimostra l'efficace meccanismo che, in un battibaleno, ne trasforma l'uso e l'aspetto. Sono numerosi i dettagli che rendono questo divano letto un elemento d'arredo speciale per ogni tipo di spazio: i porta guanciali integrati nello schienale, il materasso ad alto spessore e il robusto supporto per il riposo. Un vero protagonista del salotto, dello studio o della camera degli ospiti.

Iboo is a convertible sofa that focuses on clean lines and compact proportions. Rigor and comfort complete its image, giving it a contemporary and well-balanced character. Iboo is both a true sofa and a true bed, as demonstrated by the efficient mechanism that transforms its use and appearance in an instant. Numerous details make this sofa bed a distinctive furnishing element for any space: pillow holders integrated into the backrest, a high-thickness mattress, and a robust sleeping support. A true centerpiece for the living room, study, or guest bedroom.

ALTEZZA MATERASSO / MATTRESS HEIGHT

14 cm (materasso a molle / spring mattress)

12 cm (materasso in poliuretano / polyurethane mattress)

DIVANO LETTO MATRIMONIALE PICCOLO / DOUBLE SIZE SOFA BED

Letto / Bed 140x200 cm

DIVANO LETTO MATRIMONIALE GRANDE / KING SIZE SOFA BED

Letto / Bed 160x200 cm





Matrix

DESIGNER GIULIO MANZONI

SCHEDA TECNICA / TECHNICAL SHEET 252

Un design elegante e deciso, che richiama con leggerezza suggestioni classiche grazie ai cuscini a rullo, ai braccioli alti e ai piedini in metallo brunito opaco. Matrix resta però fedele alla sua natura funzionale un comodo letto integrato nella struttura. Progettato per durare nel tempo, unisce struttura in legno, meccanismo in maglia d'acciaio elettrosaldato e materasso in poliuretano espanso o a molle. Il rivestimento, completamente sfoderabile, è disponibile in diversi colori.

An elegant, distinctive design that lightly recalls classic inspirations with roll cushions, high armrests, and matte burnished metal feet. Matrix remains true to its functional nature, featuring a comfortable bed perfectly integrated into the structure. Designed to last over time, it combines style and strength with a wooden frame, welded steel mesh mechanism, and a mattress in polyurethane foam or springs. The fully removable cover is available in a range of colors.

ALTEZZA MATERASSO / MATTRESS HEIGHT

14 cm (materasso a molle / spring mattress)

12 cm (materasso in poliuretano / polyurethane mattress)

DIVANO LETTO MATRIMONIALE PICCOLO / DOUBLE SIZE SOFA BED DIVANO LETTO MATRIMONIALE GRANDE / KING SIZE SOFA BED

Letto / Bed 140x200 cm

Letto / Bed 160x200 cm









Piazzagrande

DESIGNER GIULIO MANZONI

SCHEDA TECNICA / TECHNICAL SHEET 262

Disponibile in due diverse dimensioni, il divano Piazzagrande presenta una generosa seduta con rivestimento trapuntato realizzabile in vari tessuti e colori. I contorni estremamente concisi sottolineano il suo carattere contemporaneo e lo stile sicuro che abbina la solidità della struttura in legno all'accoglienza del letto istantaneo con meccanismo in maglia di acciaio elettrosaldato e materasso in poliuretano espanso.

Available in two different sizes, the Piazzagrande sofa features a generous seat with quilted covering in various fabrics and colours. The extremely concise contours underline its contemporary character and the sure style that combines the solidity of the wooden structure with the welcome of the instant bed with an electrowelded steel mesh mechanism and mattress made of polyurethane foam.

ALTEZZA MATERASSO / MATTRESS HEIGHT

16 cm (materasso in poliuretano / polyurethane mattress)

DIVANO LETTO MATRIMONIALE PICCOLO / DOUBLE SIZE SOFA BED DIVANO LETTO MATRIMONIALE GRANDE / KING SIZE SOFA BED

Letto / Bed 140x195 cm

Letto / Bed 160x195 cm









Plan

DESIGNER CAMPEGGI DESIGN

SCHEDA TECNICA / TECHNICAL SHEET  264

Disponibile in versione due, tre e tre posti maxi, Plan è il divano letto pensato per chi cerca linee contemporanee, materiali di qualità e comfort totale, sia in seduta che nel piano di riposo con doghe in faggio. Lo schienale sdoppiato e pieghevole consente diverse configurazioni, mentre il letto si apre in un attimo senza rimuovere i cuscini.

Available in two-, three-, and maxi three-seater versions, Plan is the sofa bed designed for those who seek contemporary lines, high-quality materials, and total comfort, both in seating and in the beech slatted bed base. The split, foldable backrest allows multiple configurations, while the bed opens instantly without removing the cushions.

ALTEZZA MATERASSO / MATTRESS HEIGHT

12 cm (materasso a molle / spring mattress)

12 cm (materasso in poliuretano / polyurethane mattress)

DIVANO LETTO MATRIMONIALE PICCOLO / DOUBLE SIZE SOFA BED DIVANO LETTO MATRIMONIALE GRANDE / KING SIZE SOFA BED

Letto / Bed 140x195 cm

Letto / Bed 160x195 cm

ALTRE CONFIGURAZIONI / OTHER CONFIGURATIONS

Disponibile in versione fissa / Available sofa without bed





Quilt

DESIGNER GIULIO MANZONI

SCHEDA TECNICA / TECHNICAL SHEET 265

Quilt è un divano caratterizzato da una trapuntatura progressiva che crea un effetto di movimento unico, conferendo al prodotto un dinamismo avvolgente. Il bracciolo crea un dettaglio a ponte, permettendo alla seduta di fluttuare, trasmettendo così leggerezza. Quilt ha la possibilità di trasformarsi facilmente in un letto con un materasso da 16 cm, offrendo una soluzione versatile e di grande impatto. Un prodotto che mette in forte relazione estetica e funzionalità.

Quilt is a sofa defined by progressive quilting that creates a unique sense of movement and enveloping dynamism. The armrest forms a bridge-like detail, allowing the seat to appear suspended and weightless and elegance. Quilt easily transforms into a bed with a 16 cm mattress, offering a versatile and striking solution. A piece that perfectly balances aesthetics and functionality, comfort and design.

ALTEZZA MATERASSO / MATTRESS HEIGHT

16 cm (materasso in poliuretano / polyurethane mattress)

DIVANO LETTO MATRIMONIALE PICCOLO / DOUBLE SIZE SOFA BED DIVANO LETTO MATRIMONIALE GRANDE / KING SIZE SOFA BED

Letto / Bed 140x200 cm

Letto / Bed 160x200 cm









Ritz

DESIGNER GIULIO MANZONI

SCHEDA TECNICA / TECHNICAL SHEET 266

Un divano letto generoso e accogliente che si trasforma in un letto con un materasso "super". Ritz è arricchito da elementi componibili confortevoli come i braccioli extra large e ha un'allure minimalista che viene ulteriormente addolcita dal rivestimento sartoriale. Il dettaglio prezioso che è impossibile non notare è la base, in alluminio naturale satinato, disponibile anche in nero opaco e blu petrolio.

A generous and welcoming sofa bed that transforms into a bed with a "super" mattress. Ritz is enriched with comfortable modular elements such as extra-large armrests and features a minimalist allure, further softened by its tailored upholstery. The precious detail that is impossible to overlook is the base, in satin-finished natural aluminum, also available in matte black and petrol blue. Inside the Ritz sofa, an ultra-comfortable mattress awaits you. Sweet dreams!

ALTEZZA MATERASSO / MATTRESS HEIGHT

16 cm (materasso in poliuretano / polyurethane mattress)

DIVANO LETTO PIAZZA E MEZZA / SMALL DOUBLE SIZE SOFA BED
DIVANO LETTO MATRIMONIALE PICCOLO / DOUBLE SIZE SOFA BED
DIVANO LETTO MATRIMONIALE GRANDE / KING SIZE SOFA BED

Letto / Bed 120x195 cm
Letto / Bed 140x195 cm
Letto / Bed 160x195 cm

ALTRE CONFIGURAZIONI / OTHER CONFIGURATIONS

Disponibile in versione fissa / Available sofa without bed
Disponibile in versione angolare / Available modular sofa









Saiwa

DESIGNER CAMPEGGI DESIGN

SCHEDA TECNICA / TECHNICAL SHEET 267

Saiwa unisce linee morbide e un aspetto soffice a un'apertura intuitiva pensata per l'uso quotidiano. Una volta aperto, rivela un letto ampio e confortevole, dotato di un materasso in poliuretano da 16 cm che garantisce un riposo paragonabile a quello di un vero letto. È la soluzione ideale per chi cerca un elemento pratico e funzionale senza rinunciare alla qualità tipica di Campeggi.

Saiwa combines soft lines and a plush appearance with an intuitive opening system designed for everyday use. Once opened, it reveals a spacious and comfortable bed equipped with a 16-cm polyurethane mattress that ensures a level of comfort comparable to that of a real bed. It is the ideal solution for those seeking a practical and functional piece without compromising on the quality typical of Campeggi.

ALTEZZA MATERASSO / MATTRESS HEIGHT

16 cm (materasso in poliuretano / polyurethane mattress)

DIVANO LETTO MATRIMONIALE PICCOLO / DOUBLE SIZE SOFA BED DIVANO LETTO MATRIMONIALE GRANDE / KING SIZE SOFA BED

Letto / Bed 140x195 cm

Letto / Bed 160x195 cm





Soft

DESIGNER GIULIO MANZONI

SCHEDA TECNICA / TECHNICAL SHEET 272

Un divano dalle linee chiare e senza tempo, capace di arredare con equilibrio senza imporsi. Il meccanismo consente una trasformazione rapida e senza sforzo in un letto confortevole, mentre i cuscini fungono da pratici braccioli aggiuntivi. Struttura in legno, rete in maglia d'acciaio elettrosaldata e materasso in poliuretano espanso. Il rivestimento, completamente sfoderabile, è disponibile in diversi tessuti e colori.

A sofa with clear, timeless lines that furnishes any space with balance and discretion. Its mechanism allows for an effortless transformation into a comfortable bed, while the cushions serve as practical additional armrests. The structure is made of wood, with a welded steel mesh base and a polyurethane foam mattress. The fully removable cover is available in a variety of fabrics and colors.

ALTEZZA MATERASSO / MATTRESS HEIGHT

12 cm (materasso in poliuretano / polyurethane mattress)

DIVANO LETTO MATRIMONIALE PICCOLO / DOUBLE SIZE SOFA BED DIVANO LETTO MATRIMONIALE GRANDE / KING SIZE SOFA BED

Letto / Bed 140x195 cm

Letto / Bed 160x195 cm

ALTRE CONFIGURAZIONI / OTHER CONFIGURATIONS

Disponibile in versione fissa / Available sofa without bed





Tango

DESIGNER GIULIO MANZONI

SCHEDA TECNICA / TECHNICAL SHEET 272

Tango è un divano che coniuga design e qualità, pensato per chi cerca un elemento elegante per il proprio living. Le sue forme curate e il comfort non si limitano all'estetica: Tango nasconde un comodo letto con un materasso da 16cm che si apre in modo semplice e veloce. Non è solo una soluzione per gli ospiti, ma un divano pensato per chi vive in ambienti dove ogni metro quadro conta. Con Tango, design e funzionalità convivono senza compromessi, rendendo il living uno spazio da vivere a 360°.

Tango is a sofa that combines design and quality, crafted for those seeking an elegant element for their living space. Its refined shapes and exceptional comfort go beyond aesthetics: Tango hides a comfortable bed inside, featuring a 16cm mattress that opens easily and designed for everyday use, perfect for those living in spaces where every square meter counts. With Tango, design and functionality coexist without compromise, making your living area a space to enjoy 360°.

ALTEZZA MATERASSO / MATTRESS HEIGHT

16 cm (materasso in poliuretano / polyurethane mattress)

DIVANO LETTO MATRIMONIALE PICCOLO / DOUBLE SIZE SOFA BED

Letto / Bed 140x195 cm

DIVANO LETTO MATRIMONIALE GRANDE / KING SIZE SOFA BED

Letto / Bed 160x195 cm









Tip-Tap

DESIGNER GIULIO MANZONI

SCHEDA TECNICA / TECHNICAL SHEET 273

Il progetto ideale per chi cerca un divano letto dall'immagine decisa e contemporanea, dove volumi squadrati si equilibrano con linee morbide e cuciture sartoriali. Pensato per essere vissuto in entrambe le configurazioni, si distingue anche in spazi compatti senza rinunciare alla praticità d'uso e a una generosa accoglienza. I cuscini di schienale di Tip-Tap sono liberamente posizionabili e dotati di una potente calamita che li ancora alla struttura durante la trasformazione in letto. Il materasso in poliuretano espanso, ampio e spesso, offre un piano accogliente e si richiude senza sforzo. Il rivestimento sfoderabile è disponibile in diverse varianti di colore.

The ideal project for those seeking a sofa bed with a confident, contemporary look, where square volumes are balanced by softer lines and tailored seams. Designed to be enjoyed in both configurations, it stands out even in compact spaces without compromising ease of use or generous comfort, pleasant both by day and by night. The Tip-Tap backrest cushions can be freely repositioned and feature a powerful magnet that keeps them anchored to the structure when converting into a bed. The large, thick expanded polyurethane mattress provides a welcoming surface and closes effortlessly. The removable cover is available in a range of colour options.

ALTEZZA MATERASSO / MATTRESS HEIGHT

16 cm (materasso in poliuretano / polyurethane mattress)

DIVANO LETTO MATRIMONIALE PICCOLO / DOUBLE SIZE SOFA BED

Letto / Bed 140x195 cm

DIVANO LETTO MATRIMONIALE GRANDE / KING SIZE SOFA BED

Letto / Bed 160x195 cm

ALTRE CONFIGURAZIONI / OTHER CONFIGURATIONS

Disponibile in versione fissa / Available sofa without bed









Zazà

DESIGNER CAMPEGGI DESIGN

SCHEDA TECNICA / TECHNICAL SHEET 276

Un tempo il divano letto rappresentava una rinuncia, sia allo stile sia alla comodità. Con Zazà tutto cambia: un divano capace di essere protagonista grazie alle dimensioni generose, al design senza tempo e alle numerose possibilità di composizione, anche nelle versioni angolari e con chaise-longue contenitore. Zazà sa però essere anche un vero letto, grazie a un ottimo materasso e a un meccanismo di apertura inedito e particolarmente pratico, con spazio dedicato ai guanciali.

In the past sofa beds used to be a solution that somehow meant renouncing style and comfort. With Zazà everything changes. At last a sofa that can play the leading role, thanks to its generous dimensions, its timeless design and the various possibilities of composition. Available also in the corner versions or with chaise longue container. However, Zazà can also be a bed: a real bed, with a great mattress and an unusual and particularly practical opening mechanism (with a container for pillows).

ALTEZZA MATERASSO / MATTRESS HEIGHT

12 cm (materasso in poliuretano / polyurethane mattress)

POLTRONA LETTO / CHAIR BED

DIVANO LETTO PIAZZA E MEZZA / SMALL DOUBLE SIZE SOFA BED

DIVANO LETTO MATRIMONIALE PICCOLO / DOUBLE SIZE SOFA BED

DIVANO LETTO MATRIMONIALE GRANDE / KING SIZE SOFA BED

Letto / Bed 70x195 cm

Letto / Bed 120x195 cm

Letto / Bed 140x195 cm

Letto / Bed 160x195 cm

ALTRE CONFIGURAZIONI / OTHER CONFIGURATIONS

Disponibile in versione fissa / Available sofa without bed

Disponibile in versione angolare / Available modular sofa



ZAZÀ SMALL

LARGHEZZA BRACCIOLO / ARMREST WIDTH 10 cm



ZAZÀ

LARGHEZZA BRACCIOLO / ARMREST WIDTH 20 cm



ZAZÀ

LARGHEZZA BRACCIOLO / ARMREST WIDTH 35 cm







Letto a ribalta apertura da seduta

Folding bed seat opening

Aoy



92 **Flower**



94 **Giù**



96

0.scia



98 **Oa**



100

Aoy

DESIGNER CAMPEGGI DESIGN

SCHEDA TECNICA / TECHNICAL SHEET 228

Aprire o rinnovare la vostra casa scegliendo Aoy, il sistema componibile sostenuto da robusti piedi in acciaio cromato e il tessuto del rivestimento completamente sfoderabile. Questa particolare risorsa enfatizza lo stile elementare e pulito con il quale è stato realizzato. Inoltre, quando il divano si trasforma in letto con un semplicissimo intervento, vi offre la sensazione di riposare su un vero e proprio letto ben sollevato da terra, e di impatto molto resistente.

Open or renew your home with Aoy, a new modular system held up by strong chromed steel feet, covered with a completely removable fabric. This special characteristic highlights the simple and clean style of Aoy. Moreover, with an easy movement, the sofa becomes a bed and you feel like sleeping on a real bed, well lifted from the ground and resistant.

ALTEZZA MATERASSO / MATTRESS HEIGHT

12 cm (materasso a molle / spring mattress)

POLTRONA LETTO / CHAIR BED

Letto / Bed 80x195 cm

DIVANO LETTO PIAZZA E MEZZA / SMALL DOUBLE SIZE SOFA BED

Letto / Bed 120x195 cm

DIVANO LETTO MATRIMONIALE PICCOLO / DOUBLE SIZE SOFA BED

Letto / Bed 140x195 cm

ALTRE CONFIGURAZIONI / OTHER CONFIGURATIONS

Disponibile in versione fissa / Available sofa without bed

Disponibile in versione angolare / Available modular sofa





Flower

DESIGNER GIULIO MANZONI

SCHEDA TECNICA / TECHNICAL SHEET 239

Il sistema componibile Flower offre infinite possibilità per realizzare soluzioni personalizzate di sistemi accoglienti e pratici, lineari o angolari, con o senza letto, grazie ai moduli accostabili. Un elegante e accogliente divano con un letto di alta qualità con piano di riposo in maglia di acciaio elettrosaldato e materasso a molle in poliuretano espanso. Imbottitura in poliuretano espanso e ovatta poliesteri con inserti in piuma, rivestimento sfoderabile disponibile in vari colori.

The Flower modular system allows you to build countless customised solutions, with cosy convenient linear or corner systems, with or without bed, thanks to its fitting modules. An elegant and cosy sofa, featuring a high-quality bed with an electrowelded steel mesh rest surface and a spring or polyurethane foam mattress. Padding made of polyurethane foam and polyester wadding with down inserts, removable cover available in multiple colours.

ALTEZZA MATERASSO / MATTRESS HEIGHT

12 cm (materasso a molle / spring mattress)

DIVANO LETTO PIAZZA E MEZZA / SMALL DOUBLE SIZE SOFA BED
DIVANO LETTO MATRIMONIALE PICCOLO / DOUBLE SIZE SOFA BED
DIVANO LETTO MATRIMONIALE GRANDE / KING SIZE SOFA BED

Letto / Bed 120x190 cm
Letto / Bed 140x190 cm
Letto / Bed 160x190 cm

ALTRE CONFIGURAZIONI / OTHER CONFIGURATIONS

Disponibile in versione fissa / Available sofa without bed
Disponibile in versione angolare / Available modular sofa





Giù

DESIGNER CAMPEGGI DESIGN

SCHEDA TECNICA / TECHNICAL SHEET  241

Per un ambiente semplice ed elegante ci pensa Giù, il nuovo divano sostenuto da robusti piedi in alluminio satinato. Questa particolare caratteristica enfatizza lo stile elementare e pulito del prodotto. Quando il divano si trasforma, offre la sensazione di riposare su un vero e proprio letto.

For a simple and elegant environment, we have Giù, the new sofa supported by sturdy satinfinished aluminum feet. This particular feature emphasizes the elementary, clean style of the product. When the sofa transforms, it offers the feeling of resting on a real bed.

ALTEZZA MATERASSO / MATTRESS HEIGHT

12 cm (materasso a molle / spring mattress)

POLTRONA LETTO / CHAIR BED

Letto / Bed 80x195 cm

DIVANO LETTO PIAZZA E MEZZA / SMALL DOUBLE SIZE SOFA BED

Letto / Bed 120x195 cm

DIVANO LETTO MATRIMONIALE PICCOLO / DOUBLE SIZE SOFA BED

Letto / Bed 140x195 cm

DIVANO LETTO MATRIMONIALE GRANDE / KING SIZE SOFA BED

Letto / Bed 160x195 cm





O.scià

DESIGNER CAMPEGGI DESIGN

SCHEDA TECNICA / TECHNICAL SHEET 255

Volumi importanti e linee decise caratterizzano la seduta del divano letto O.scià, il cui profilo è improntato all'eccellenza a partire dalla qualità del rivestimento e dalla composta eleganza della linea: un divano classico senza tempo che si inserisce in ogni ambiente, caratterizzandolo con un segno di valore. Versatile per il giorno e per la notte, disponibile anche nella versione angolare, si trasforma con semplicità: il piano di riposo si apre senza necessità di rimuovere i cuscini.

Bold volumes and defined lines characterize the seating of the O.scià sofa bed, whose profile reflects excellence, beginning with the quality of the upholstery and the composed elegance of its design: a timeless classic sofa that fits seamlessly into any setting, enhancing it with a distinctive sense of value. Versatile for both day and night use, and also available in a corner version, it transforms with ease: the sleeping surface opens without the need to remove the cushions.

ALTEZZA MATERASSO / MATTRESS HEIGHT

12 cm (materasso a molle / spring mattress)

DIVANO LETTO MATRIMONIALE PICCOLO / DOUBLE SIZE SOFA BED DIVANO LETTO MATRIMONIALE GRANDE / KING SIZE SOFA BED

Letto / Bed 140x195 cm
Letto / Bed 160x195 cm

ALTRE CONFIGURAZIONI / OTHER CONFIGURATIONS

Disponibile in versione fissa / Available sofa without bed
Disponibile in versione angolare / Available modular sofa





Oa

DESIGNER CAMPEGGI DESIGN

SCHEDA TECNICA / TECHNICAL SHEET 257

Con seduta profonda, comoda e accogliente e stile rigoroso e pulito, dalle linee squadrate appena ammorbidite dai cuscini poggiatesta, Oa è un divano letto progettato a regola d'arte. La stessa eccellenza di lavorazione, materiali e forme è applicata al letto estraibile, rispettoso dell'ergonomia del sonno. Oa è sempre pronto da usare, rapido e leggero da aprire, senza rimuovere i cuscini di seduta e schienale.

Characterized by a wide, comfortable and cosy seat, a rigorous and clean design with square lines softened by back cushions, Oa is a work of art. The same excellence of its finishing, materials and forms has been applied to the extendable bed respectful of sleeping ergonomics. Oa is always ready to be used, it is light and easy to unfold without removing the seat and back cushions.

ALTEZZA MATERASSO / MATTRESS HEIGHT

12 cm (materasso a molle / spring mattress)

DIVANO LETTO PIAZZA E MEZZA / SMALL DOUBLE SIZE SOFA BED
DIVANO LETTO MATRIMONIALE PICCOLO / DOUBLE SIZE SOFA BED
DIVANO LETTO MATRIMONIALE GRANDE / KING SIZE SOFA BED

Letto / Bed 120x195 cm
Letto / Bed 140x195 cm
Letto / Bed 160x195 cm

ALTRE CONFIGURAZIONI / OTHER CONFIGURATIONS

Disponibile in versione fissa / Available sofa without bed





Letto estraibile

Pull-out bed

Bye



104 **Fefè**



106 **Olo**



108

Sky Uno



110 **Sky Due**



112 **Sky Tre**



114

Bye

DESIGNER CAMPEGGI DESIGN

SCHEDA TECNICA / TECHNICAL SHEET 233

Qui abbiamo un vero letto, sintesi dell'esperienza consolidata della nostra azienda. Bye è un prodotto capace di moltiplicare le proprie funzioni grazie alla sua personalità versatile e "polifonica". È un divano con seduta composta da un materasso sfoderabile, utilizzabile come letto singolo, sotto il quale è integrato un secondo letto estraibile che permette di ottimizzare anche gli spazi più contenuti. In alternativa, completa il sistema un pratico contenitore, pensato per sfruttare ogni centimetro disponibile. Un movimento semplice e rapido consente di sollevare la rete senza doversi piegare.

Here we have a real bed, the synthesis of our company's consolidated expertise. Bye is a product capable of multiplying its functions thanks to its versatile, "polyphonic" personality. It is a sofa with a seat composed of a removable mattress, usable as a single bed, beneath which a second pull-out bed is integrated, allowing even the most compact spaces to be optimized. Alternatively, is completed by a practical storage compartment, designed to make use of every available centimeter. A simple and quick movement allows the bed base to be lifted without the need to bend down.

ALTEZZA MATERASSO / MATTRESS HEIGHT

14 cm (materasso a molle / spring mattress)

14 cm (materasso in poliuretano / polyurethane mattress)

DIVANO LETTO SINGOLO / SMALL SINGLE SOFA BED

Letto / Bed 75x187 cm

DIVANO LETTO SINGOLO E SECONDO LETTO / SMALL SINGLE SOFA BED WITH TWIN BED

Letto / Bed 150x187 cm



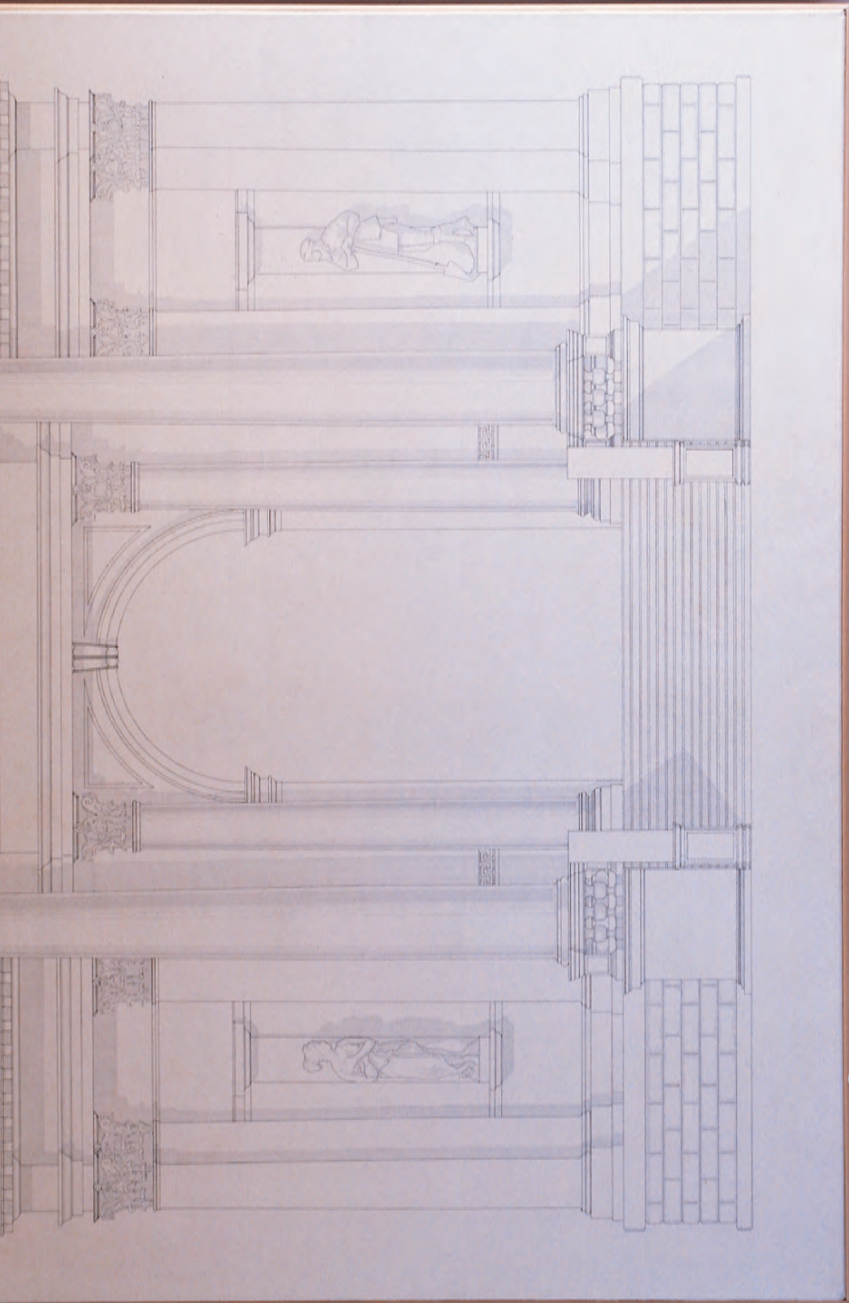
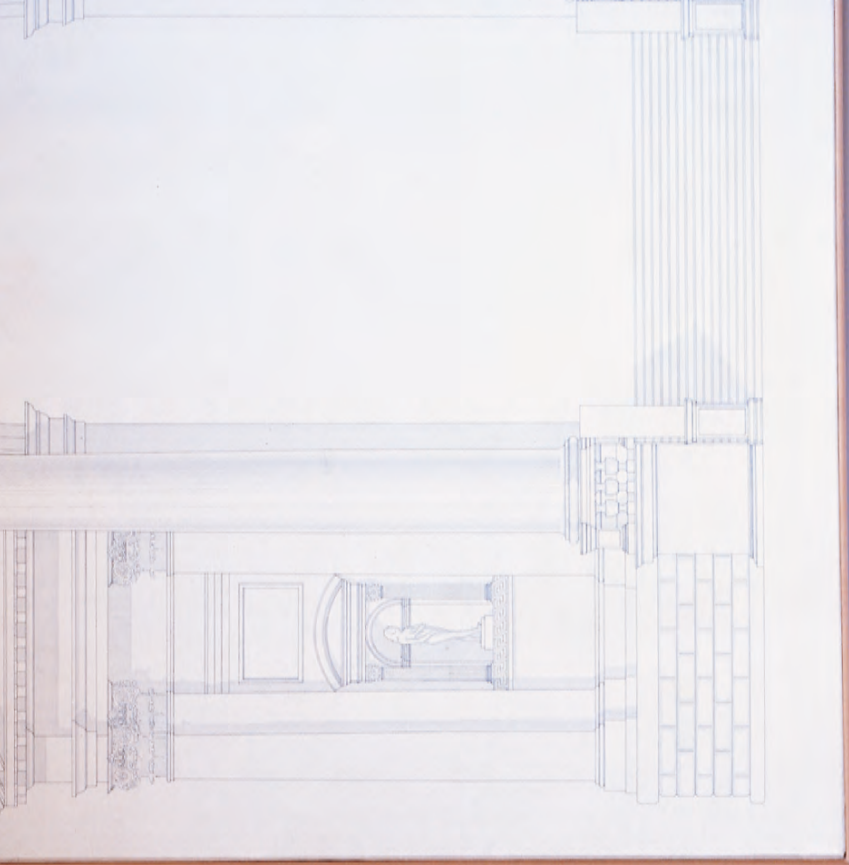

Fefè

DESIGNER CAMPEGGI DESIGN

SCHEDA TECNICA / TECHNICAL SHEET 238

Linee pulite e tese definiscono Fefè, divano letto che integra un meccanismo di apertura ai massimi livelli di funzionalità: pratico, leggero, silenzioso, pronto in pochi gesti. La base letto, essenziale e rigorosa, diventa matrice formale di un divano dall'aspetto quasi astratto, capace di inserirsi con naturalezza in contesti diversi. Fefè è un divano letto dal design senza tempo, sintesi equilibrata tra estetica e comfort: imbottitura in poliuretano espanso, rivestimento completamente sfoderabile, struttura del letto in acciaio ad alta resistenza e supporto su ampie fasce in faggio stratificato. Comfort e affidabilità sono parte integrante del progetto.

Clean, taut lines define Fefè, a sofa bed that integrates a mechanism engineered for top-level functionality: practical, lightweight, silent, and ready in just a few movements. The bed base, essential and rigorously designed, becomes the formal matrix of a nearly abstract sofa, capable of fitting naturally into a variety of settings. Fefè is a timeless sofa bed, a balanced synthesis of aesthetics and comfort: polyurethane foam padding, fully removable cover, high-resistance steel bed frame, and support provided by wide laminated beech slats. Comfort and reliability are integral to the project.

ALTEZZA MATERASSO / MATTRESS HEIGHT

13 cm (materasso in poliuretano / polyurethane mattress)

DIVANO LETTO SINGOLO / SMALL SINGLE SOFA BED

Letto / Bed 80x195 cm

DIVANO LETTO SINGOLO E SECONDO LETTO / SMALL SINGLE SOFA BED WITH TWIN BED

Letto / Bed 155x195 cm





Olo

DESIGNER CAMPEGGI DESIGN

SCHEDA TECNICA / TECHNICAL SHEET 259

Un divano letto è davvero riuscito quando unisce un piano di riposo affidabile e facile da usare a una seduta confortevole, senza rinunciare a qualità e personalità. Olo raggiunge questo equilibrio grazie a un sistema letto ampio e altamente configurabile in spazi ridotti: un vero divano trasformabile che combina estetica di alto livello e prestazioni eccellenti.

A sofa bed is truly successful when it combines a reliable, easy-to-use bed system with a comfortable seat, without compromising on quality or character. Olo achieves this balance with a spacious, highly configurable bed system designed for compact spaces: a true convertible sofa that blends top-tier aesthetics with outstanding performance.

ALTEZZA MATERASSO / MATTRESS HEIGHT

14 cm (materasso a molle / spring mattress)

14 cm (materasso in poliuretano / polyurethane mattress)

14 cm (materasso in memory foam / memory foam mattress)

DIVANO LETTO SINGOLO / SMALL SINGLE SOFA BED

Letto / Bed 85x195 cm

DIVANO LETTO SINGOLO E SECONDO LETTO / SMALL SINGLE SOFA BED WITH TWIN BED

Letto / Bed 165x195 cm



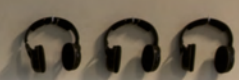

Sky Uno

DESIGNER CAMPEGGI DESIGN

SCHEDA TECNICA / TECHNICAL SHEET 268

Sky riunisce diverse soluzioni in un unico sistema: un divano con braccioli che diventa facilmente un letto singolo rimuovendo i cuscini, oppure una dormeuse con schienale e bracciolo ancora più semplice da aprire. Sotto la seduta si può inserire un secondo letto o un ampio vano contenitore. Il piano è in faggio stratificato, il materasso in poliuretano espanso o a molle, con rivestimento completamente sfoderabile.

Sky combines multiple solutions in a single system: a sofa with armrests that easily turns into a single bed by removing the cushions, or a dormeuse with backrest and armrest, even easier to open. Beneath the seat, a second bed or a large storage compartment can be added. The base is made of layered beech, the mattress in polyurethane foam or springs, with a fully removable cover.

ALTEZZA MATERASSO / MATTRESS HEIGHT

14 cm (materasso a molle / spring mattress)

14 cm (materasso in poliuretano / polyurethane mattress)

DIVANO LETTO SINGOLO / SMALL SINGLE SOFA BED

Letto / Bed 75x187 cm

DIVANO LETTO SINGOLO E SECONDO LETTO / SMALL SINGLE SOFA BED WITH TWIN BED

Letto / Bed 150x187 cm



DIVANO LETTO CON BRACCIOLI LARGHI / SOFA BED WITH WIDE ARMRESTS



Sky Due

DESIGNER CAMPEGGI DESIGN

SCHEDA TECNICA / TECHNICAL SHEET 269

Sky riunisce diverse soluzioni in un unico sistema: un divano con braccioli che diventa facilmente un letto singolo rimuovendo i cuscini, oppure una dormeuse con schienale e bracciolo ancora più semplice da aprire. Sotto la seduta si può inserire un secondo letto o un ampio vano contenitore. Il piano è in faggio stratificato, il materasso in poliuretano espanso o a molle, con rivestimento completamente sfoderabile.

Sky combines multiple solutions in a single system: a sofa with armrests that easily turns into a single bed by removing the cushions, or a dormeuse with backrest and armrest, even easier to open. Beneath the seat, a second bed or a large storage compartment can be added. The base is made of layered beech, the mattress in polyurethane foam or springs, with a fully removable cover.

ALTEZZA MATERASSO / MATTRESS HEIGHT

14 cm (materasso a molle / spring mattress)

14 cm (materasso in poliuretano / polyurethane mattress)

DIVANO LETTO SINGOLO / SMALL SINGLE SOFA BED

Letto / Bed 75x187 cm

DIVANO LETTO SINGOLO E SECONDO LETTO / SMALL SINGLE SOFA BED WITH TWIN BED

Letto / Bed 150x187 cm



DIVANO LETTO CON BRACCIOLI STRETTI / SOFA BED WITH SLIM ARMRESTS





Sky Tre

DESIGNER CAMPEGGI DESIGN

SCHEDA TECNICA / TECHNICAL SHEET  270

Sky riunisce diverse soluzioni in un unico sistema: un divano con braccioli che diventa facilmente un letto singolo rimuovendo i cuscini, oppure una dormeuse con schienale e bracciolo ancora più semplice da aprire. Sotto la seduta si può inserire un secondo letto o un ampio vano contenitore. Il piano è in faggio stratificato, il materasso in poliuretano espanso o a molle, con rivestimento completamente sfoderabile.

Sky combines multiple solutions in a single system: a sofa with armrests that easily turns into a single bed by removing the cushions, or a dormeuse with backrest and armrest, even easier to open. Beneath the seat, a second bed or a large storage compartment can be added. The base is made of layered beech, the mattress in polyurethane foam or springs, with a fully removable cover.

ALTEZZA MATERASSO / MATTRESS HEIGHT

14 cm (materasso a molle / spring mattress)

14 cm (materasso in poliuretano / polyurethane mattress)

DIVANO LETTO SINGOLO / SMALL SINGLE SOFA BED

Letto / Bed 75x187 cm

DIVANO LETTO SINGOLO E SECONDO LETTO / SMALL SINGLE SOFA BED WITH TWIN BED

Letto / Bed 150x187 cm



DIVANO LETTO SENZA BRACCIOLI, CON BRACCIOLI ALTI, CON BRACCIOLO ALTO DX O SX / SOFA BED WITHOUT ARMRESTS, WITH HIGH ARMRESTS, OR WITH A HIGH RIGHT OR LEFT ARMREST



Letto trasversale

Transverse bed

Di-Tra-Verso

118



Di-tra-verso

DESIGNER CAMPEGGI DESIGN

SCHEDA TECNICA / TECHNICAL SHEET 237

Di-Tra-Verso è un divano letto pensato per ottimizzare lo spazio senza rinunciare al comfort. L'apertura trasversale consente di trasformarlo facilmente in letto, riducendo l'ingombro. A differenza dei modelli tradizionali, la posizione di riposo si sviluppa sul lato lungo, offrendo una soluzione compatta e funzionale. Un divano che unisce praticità e design senza compromessi.

Di-Tra-Verso is a sofa bed designed to optimize space without sacrificing comfort. Its transverse opening allows it to transform easily into a bed while minimizing overall footprint. Unlike traditional sofa beds, the sleeping position runs along the length of the sofa, offering a more compact and functional solution. A sofa that perfectly combines practicality and design without compromise.

ALTEZZA MATERASSO / MATTRESS HEIGHT

12 cm (materasso in poliuretano / polyurethane mattress)

DIVANO LETTO TRASVERSALE / TRANSVERSE SOFA BED

Letto / Bed 155x200 cm

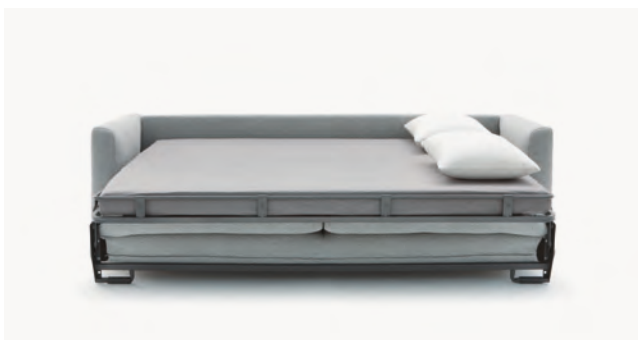



Pronto letto ad alzata frontale Ready-to-use bed with front lift

Dadà



122 Dandy



124 Istante



126

Dadà

DESIGNER CAMPEGGI DESIGN

SCHEDA TECNICA / TECHNICAL SHEET 236

Nome breve, vita lunga per questo piccolo grande divano. Piccolo sicuramente nel prezzo e nelle dimensioni, grande nella capacità e nelle prestazioni del letto; immediatamente pronto all'uso con il lenzuolo di cotone. La coperta lavabile è disponibile in vari tessuti. Leggermente imbottito con morbida ovatta è il rivestimento per il giorno e la coltre per la notte si ottiene slacciando un piccolo alamaro di legno.

Short name, long life; these are the keyfeatures of this small yet large divan. Very reasonable prices and dimensions offering a large sleeping capacity and performance. Immediately ready to use, this bed comes with a cotton sheet. The cover is washable and removable available in many colours. The day cover is slightly filled with padding, while the night cover can be extracted by simply loosening a small wooden frog.

ALTEZZA MATERASSO / MATTRESS HEIGHT

12 cm (materasso in poliuretano / polyurethane mattress)

POLTRONA LETTO / CHAIR BED

Letto / Bed 85x187 cm

DIVANO LETTO PIAZZA E MEZZA / SMALL DOUBLE SIZE SOFA BED

Letto / Bed 120x187 cm

DIVANO LETTO MATRIMONIALE / KING SIZE SOFA BED

Letto / Bed 160x187 cm





Dandy

DESIGNER CAMPEGGI DESIGN

SCHEDA TECNICA / TECHNICAL SHEET 236

Dandy è un divano letto avvolgente, morbido e dotato di rivestimento sfoderabile. I suoi braccioli, aprendosi, diventano pratici piani d'appoggio. Al suo interno nasconde un comodo letto, ideale per piccoli spazi arredati con gusto e armonia. Dandy colpisce per la facilità con cui si trasforma e per la sua compattezza. È disponibile con letto nella versione piazza e mezza, matrimoniale piccolo, matrimoniale grande e gemellare, oltre che nella versione poltrona letto.

Dandy is a welcoming, soft sofa bed with a removable cover. Its armrests open to become practical side surfaces. Inside, it conceals a comfortable bed, ideal for small spaces furnished with taste and harmony. Dandy stands out for the ease with which it transforms and for its compact proportions. It is available with a three-quarter bed, small double, large double, or twin configuration, as well as in an armchair bed version.

ALTEZZA MATERASSO / MATTRESS HEIGHT

12 cm (materasso in poliuretano / polyurethane mattress)

POLTRONA LETTO / CHAIR BED

Letto / Bed 85x187 cm

DIVANO LETTO PIAZZA E MEZZA / SMALL DOUBLE SIZE SOFA BED

Letto / Bed 120x187 cm

DIVANO LETTO MATRIMONIALE PICCOLO / DOUBLE SIZE SOFA BED

Letto / Bed 145x187 cm

DIVANO LETTO MATRIMONIALE GRANDE / KING SIZE SOFA BED

Letto / Bed 160x187 cm

DIVANO LETTO GEMELLARE / TWIN BED

Letto / Bed 170x187 cm





Istante

DESIGNER CAMPEGGI DESIGN

SCHEDA TECNICA / TECHNICAL SHEET 249

È il trasformabile più essenziale della collezione: Istante si presenta come un giovane dalla faccia pulita, pronto ad assolvere alle funzioni di essere letto o divano, senza contrastare per nulla con l'ambiente in cui si inserisce. Materasso e plumette, ripiegati appositamente, formano schienale e seduta del divano minimalista e lineare. All'interno, come sempre perfettamente celato, un agile meccanismo trasforma Istante in un comodo letto, che come la versione divano, supera ogni tentazione di moda. Trapunta separabile dal rivestimento. Struttura in acciaio, supporto rete in faggio stratificato con ammortizzatori in resina. Materasso in poliuretano espanso ad alta densità. Bracciolo accessorio destro o sinistro, regolabile.

The most functional convertible of the collection: Istante is like a fresh-faced youth, ready to work as a bed or a sofa without clashing with its surroundings. Mattress and plumette, folded as necessary, form the seat and back of the minimalist linear sofa, free of all decorative elements. Inside, perfectly concealed as always, an agile mechanism converts it into a comfortable bed which, like the divan. Quilt that can be separated from the covering. Steel structure, mattress support in layered beech with resin dampers. High density expanded polyurethane mattress. Right or left arm accessory, adjustable in three positions, with removable cover, in steel or expanded polyurethane. Small accessory table in white enamelled steel, right or left.

ALTEZZA MATERASSO / MATTRESS HEIGHT

12 cm (materasso in poliuretano / polyurethane mattress)

POLTRONA LETTO / CHAIR BED

Letto / Bed 85x187 cm

DIVANO LETTO PIAZZA E MEZZA / SMALL DOUBLE SIZE SOFA BED

Letto / Bed 120x187 cm

DIVANO LETTO MATRIMONIALE / KING SIZE SOFA BED

Letto / Bed 160x187 cm





Letto a libro - meccanismo a pettine Book-style bed - comb mechanism

Dudù



130 Oblò



210

Dudù

DESIGNER CAMPEGGI DESIGN

SCHEDA TECNICA / TECHNICAL SHEET 237

Un divano versatile e un letto sorprendente, Dudù è un divano letto giovane e fresco per una o due persone. I suoi colori vivaci lo rendono perfetto per ambienti dinamici e informali, in città o in campagna. Le linee sono impreziosite da una fascia in acero naturale lucido che ne delinea la struttura, completandone il design.

A versatile sofa and surprising bed Dudù is a young, fresh sofa bed for one or two people. Its lively colours make it perfect for upbeat, casual décors in town or country homes. Its lines are broken up by a band of natural polished maple that delineates its structure, making it complete.

ALTEZZA MATERASSO SINGOLO / SINGLE MATTRESS HEIGHT

20 cm (materasso in poliuretano / polyurethane mattress)

ALTEZZA MATERASSO DOPPIO / DOUBLE MATTRESS HEIGHT

10 cm (materasso in poliuretano / polyurethane mattress)

DIVANO LETTO SINGOLO / SINGLE SOFA BED

Letto / Bed 77x192 cm

DIVANO LETTO MATRIMONIALE / SUPER KING SIZE SOFA BED

Letto / Bed 154x192 cm



SPORGENZA MATERASSO / MATTRESS OVERHANG 14 cm



Divano Sofa

Country.club



134 Express



206

Country.club

DESIGNER CAMPEGGI DESIGN

SCHEDA TECNICA / TECHNICAL SHEET 234

Country.club è un divano piccolo ma completo, mai ingombrante grazie alla sua forma stilizzata e sintetica. Le sue eleganti finiture, la sua grazia, le bordure sempre curvilinee e dolci, la stoffa allegra, moderna e completamente lavabile ne fanno un prodotto destinato al sicuro successo. Country.club è un grande divano che, grazie alla sua forma compatta, può essere impiegato con grande facilità e flessibilità nel tuo arredamento e che è disponibile nella versione due posti, tre posti e poltrona.

A great little sofa with a pouff. Country.club is a small but complete sofa that thanks to its stylized and simplified shape is never cumbersome. With its elegant finish, its grace, the soft curved lines of the borders, the happy fabrics, modern and completely washable, all make a product destined for sure success. Country.club is a great sofa that thanks to its compactness, can be slotted into your furnishing scheme with great ease and flexibility.





Poltrone Letto

Armchair Bed

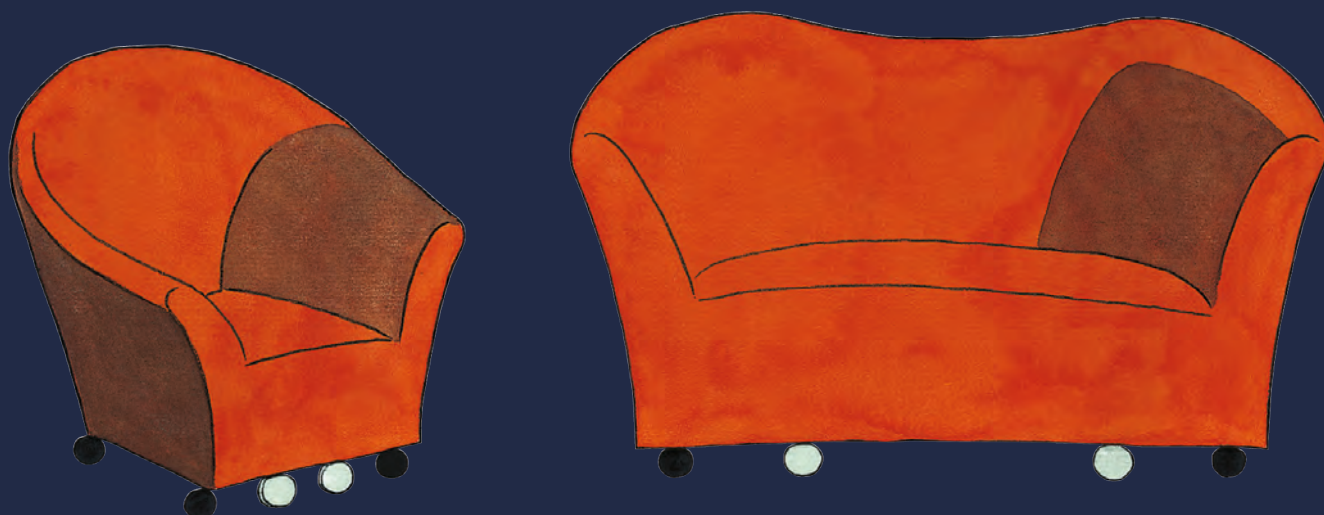

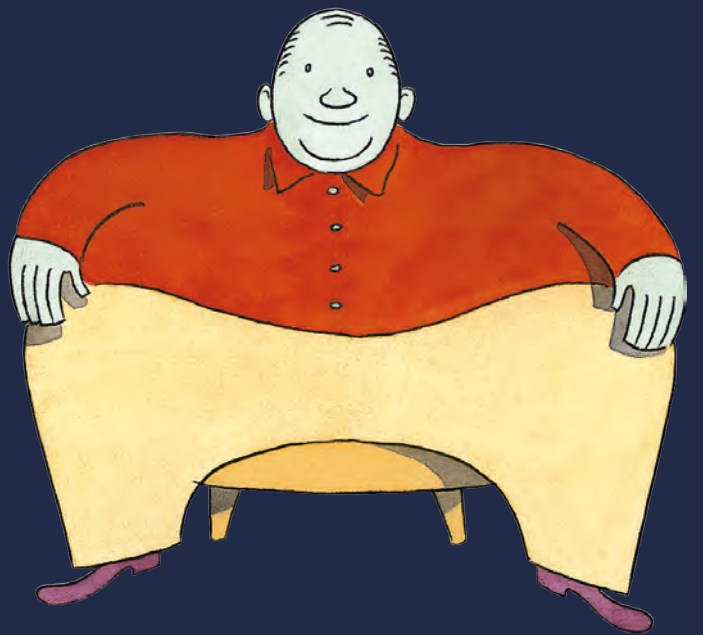

Poltrone Letto

Armchair Bed

**LETTO ORTOGONALE
ORTHOGONAL BED**

Acca

140



**LETTO A LIBRO - MECCANISMO A LIBRO
BOOK-STYLE BED - BOOK MECHANISM**

Bibi

142 **Zoe**

144



**LETTO PIANO SOVRAPPONTO
OVERLAPPING BED**

Babu

146 **Micia**

148



Oops

150 **Virgola**

152



Acca

DESIGNER GIULIO MANZONI

SCHEDA TECNICA / TECHNICAL SHEET 226

Acca è la poltrona-letto dall'aspetto di un cubo morbido e accogliente. Disegnata da Giulio Manzoni, nasconde una nuova tipologia di seduta trasformabile: poltrona, chaise longue e letto singolo. Acca si adatta con facilità alle necessità del momento e si sposta agevolmente da una stanza all'altra grazie alle ruote e alle dimensioni contenute, che le permettono di attraversare senza difficoltà una porta standard. Il cuscino della seduta, dotato di piedini, diventa un pratico comodino imbottito, mentre il caveau sottostante può contenere la biancheria per il letto.

A soft and cosy cube, designed by Giulio Manzoni hides a new kind of convertible seat: armchair, chaise longue and single bed. Acca can be easily adapted as required from time to time and it can be freely moved from one room to another thanks to its castors and to its contained proportions which can comfortably fit through standard sized doors. The seat cushion, provided with feet, can be converted into a padded bedside table and the space underneath can contain the bed linen.

ALTEZZA MATERASSO / MATTRESS HEIGHT

12 cm (materasso in poliuretano / polyurethane mattress)

POLTRONA LETTO / CHAIR BED

Letto / Bed 75x204 cm



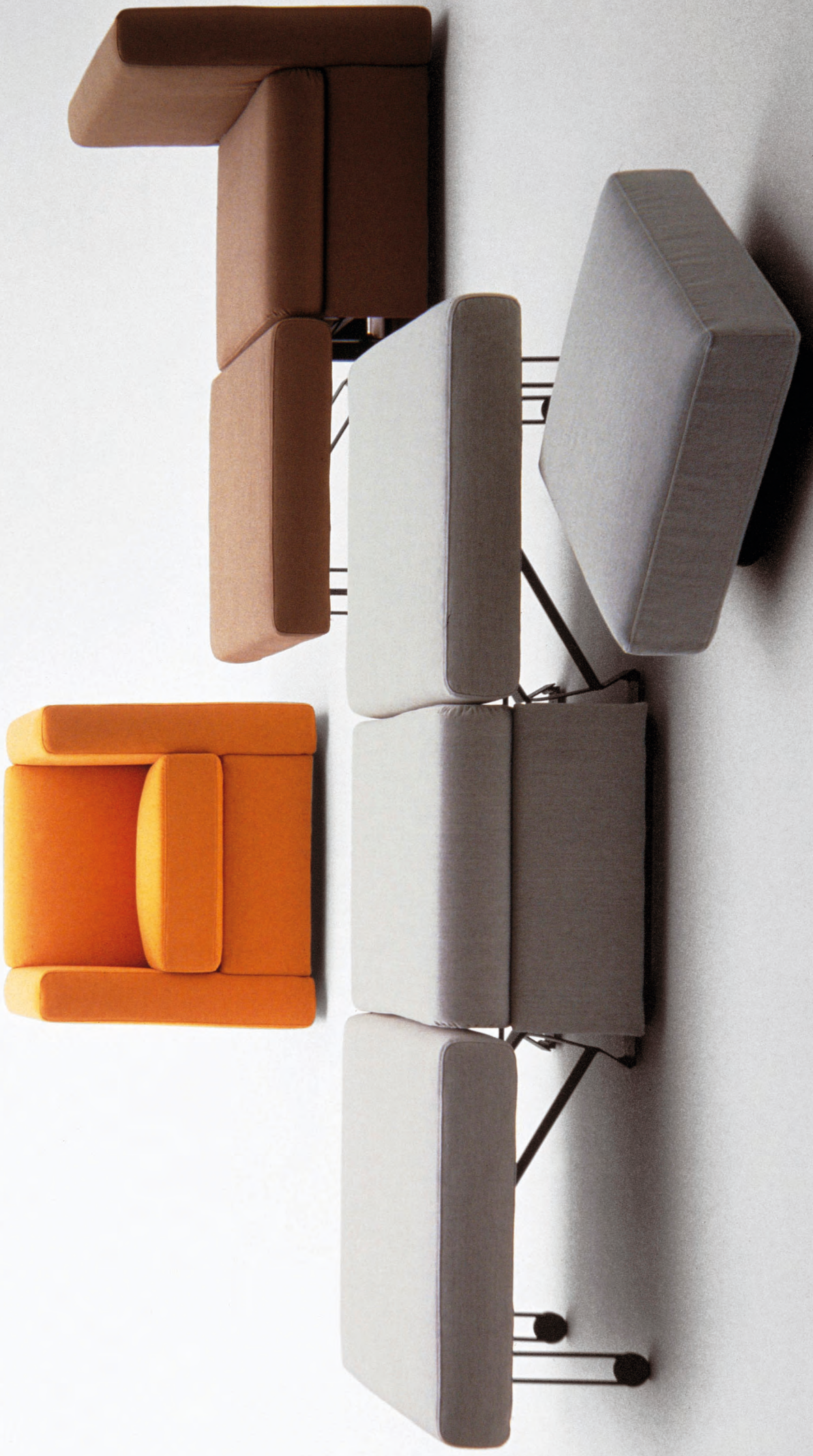

Bibi

DESIGNER CAMPEGGI DESIGN

SCHEDA TECNICA / TECHNICAL SHEET 230

Con la sua linea essenziale e la praticità di utilizzo, Bibi si adatta a tutti gli ambienti. Per trasformarla da poltrona a letto, non serve altro che sollevare la fodera "a cappuccio". Il comfort del dormire è assicurato dal piano riposo in faggio stratificato e dal materasso in poliuretano espanso senza CFC. Il rivestimento sfoderabile è disponibile in molteplici varianti di colore.

Bibi is suitable for all environments thanks to its essential design and easy use. All you need to do to turn the chair into a bed is to lift off the hooded cover. A sound sleep is ensured by the laminated beech base and the free CFC polyurethane foam mattress. Removable covers available in various colors confirm Bibi's versatility.

ALTEZZA MATERASSO / MATTRESS HEIGHT

11 cm (materasso in poliuretano / polyurethane mattress)

POLTRONA LETTO / CHAIR BED

Letto / Bed 75x185 cm





Zoe

DESIGNER CAMPEGGI DESIGN

SCHEDA TECNICA / TECHNICAL SHEET 280

Zoe è un prodotto unico: si adatta ai piccoli ambienti e, grazie alla sua versatilità, può essere poltrona, letto pronto all'uso per la camera dei ragazzi, divanetto e letto per una coppia di giovani. Oppure aprirsi con un semplice movimento per accogliere un ospite. La sua stuoia lavabile, la solidità della struttura, ne fanno uno dei trasformabili più ricchi di soluzioni tecnologiche.

Zoe is unique: it is suitable for small spaces and thanks to its versatility can be an armchair, a bed for the children's room or a sofa-bed for a young couple. Or it can be opened in a jiffy to put up a guest. Its washable covers and solid structure make it one of the most technologically sophisticated convertibles.

ALTEZZA MATERASSO / MATTRESS HEIGHT

11 cm (materasso in poliuretano / polyurethane mattress)

POLTRONA LETTO / CHAIR BED

Letto / Bed 75x185 cm

DIVANO LETTO MATRIMONIALE / DOUBLE SIZE SOFA BED

Letto / Bed 140x185 cm

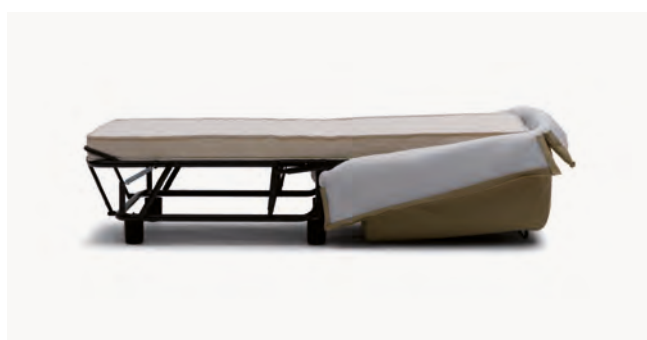



Babu

DESIGNER CAMPEGGI DESIGN

SCHEDA TECNICA / TECHNICAL SHEET 230

Quando l'obiettivo è la ricerca di un arredo versatile, la poltroncina Babu colpisce nel segno grazie alla sua generosa essenzialità. Una seduta soffice e compatta, ma anche un letto singolo subito pronto, pensato per accogliere l'ospite imprevisto grazie al pratico meccanismo che si apre e si chiude in un semplice gesto. La silhouette leggera e le numerose opzioni di rivestimento tessile a cappuccio la rendono adatta a tutti gli ambienti e i contesti dell'abitare.

When the goal is finding a versatile design, the Babu armchair hits the mark thanks to its generous essentiality. It is a soft, compact seat, but also an immediately ready single bed, designed to welcome the unexpected guest thanks to the practical mechanism that opens and closes with a simple gesture. The light silhouette and the numerous options of the textile hood cover make it suitable for all living environments and contexts.

ALTEZZA MATERASSO / MATTRESS HEIGHT

10 cm (materasso in poliuretano / polyurethane mattress)

POLTRONA LETTO / CHAIR BED

Letto / Bed 75x198 cm





Micia

DESIGNER PAOLO IMPERATORI

SCHEDA TECNICA / TECHNICAL SHEET  253

Poltroncina dall'aria informale che unisce tecnologia e cura artigianale per offrire il massimo comfort, sia nel riposo quotidiano che nell'accoglienza di un ospite. In meno di un metro quadrato concentra tutto: piano riposo in maglia d'acciaio elettrosaldato, materasso in poliuretano espanso e morbido guanciaie che di giorno diventa schienale. Lo stile è minimale, ma arricchito da dettagli sartoriali: la cover trapuntata, chiusa da alamari, si piega formando le classiche "orecchie", un tocco familiare e affettuoso.

Informal armchair that combines technology and craftsmanship to offer maximum comfort, for everyday relaxation or welcoming a guest. In less than one square meter, it includes everything: a welded steel mesh bed base, a polyurethane foam mattress, and a soft pillow that becomes a backrest during the day. The style is minimal yet refined, with tailored details: the quilted cover, fastened with toggles, folds into the signature "ears", a charming, familiar touch.

ALTEZZA MATERASSO / MATTRESS HEIGHT

10 cm (materasso in poliuretano / polyurethane mattress)

POLTRONA LETTO / CHAIR BED

Letto / Bed 75x198 cm





Oops

DESIGNER GIULIO MANZONI

SCHEDA TECNICA / TECHNICAL SHEET 261

Less is more: forme semplici su base squadrata e minimalismo formale in un progetto di interior design firmato Giulio Manzoni. Oops è una poltrona imbottita compatta ma super-trasformabile, un configuratore di relax che rende disponibili un doppio letto singolo o un letto singolo con comodino, un pouf o una poltrona con schienale e braccioli.

Less is more: simple shapes on a square and minimal base for one of Giulio Manzoni's designs. Oops is a super convertible solid easy chair a relaxing form which can become a twin double bed or a single bed with a bedside table, a pouf or an armchair with backrest and armrests.

ALTEZZA MATERASSO / MATTRESS HEIGHT

10 cm (materasso in poliuretano / polyurethane mattress)

POLTRONA LETTO SINGOLO E SECONDO LETTO / SMALL SINGLE CHAIR BED WITH TWIN BED

Letto / Bed 71x201 cm

Letto / Bed 139x201 cm





Virgola

DESIGNER GIULIO MANZONI

SCHEDA TECNICA / TECHNICAL SHEET  274

Dal sedile si solleva un nastro sagomato a virgola che lo avvolge, trasformandosi in bracciolo e schienale di una poltrona letto compatta. Accostando due Virgola si ottiene un elegante divanetto o un comodo letto matrimoniale: la soluzione trasformabile perfetta!

From the seat rises a curved ribbon shape that wraps around it, becoming the armrest and backrest of a compact armchair bed. Placing two Virgola side by side creates an elegant loveseat or a comfortable double bed: the perfect transforming solution!

ALTEZZA MATERASSO / MATTRESS HEIGHT

10 cm (materasso in poliuretano / polyurethane mattress)

POLTRONA LETTO / CHAIR BED

Letto / Bed 68x202 cm





Trasformabili

Multifunctional Products

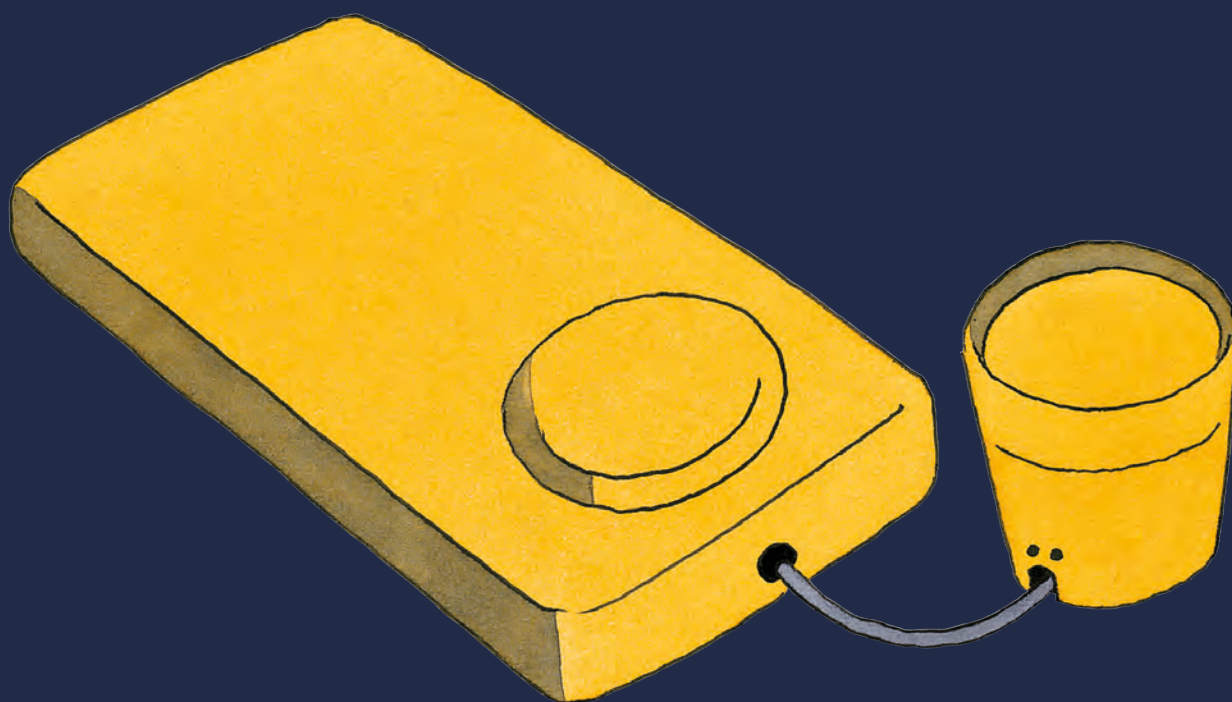

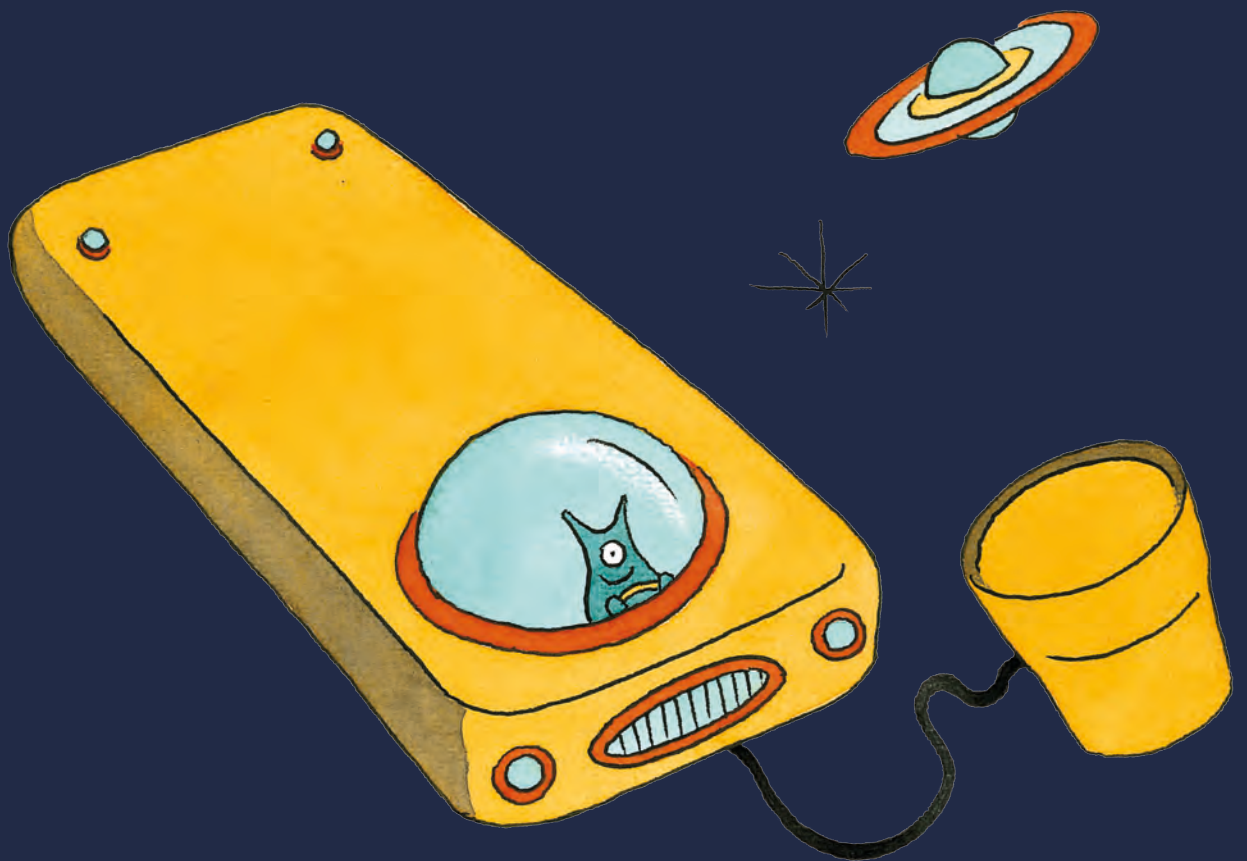

Trasformabili

Multifunctional Products

Bitta 158 Brando 160 Canispè 164



Gilbert & George 166 Ipno 168 Kai 170



Lazy Basketball 172 Le Temps de la Communauté 174 Maracanà 176



Mehari 178 Moby 182 Pisola 184



Q. letto 186 Siesta 188 Tutù 190



Underdog 192 Yaki 194 Zoom 196



Bitta

DESIGNER DENIS SANTACHIARA

SCHEDA TECNICA / TECHNICAL SHEET 231

Ancora una metamorfosi per il letto trasformabile di design per eccellenza ideato da Denis Santachiara, Bitta strizza l'occhio al mondo marinaro richiamando il profilo di una bitta da ormeggio. Da utilizzare come morbida seduta, Bitta nasconde un comodo letto singolo autogonfiabile dotato di gonfiatore/sgonfiatore elettrico.

Yet another shape change for this top-class convertible, designed by Denis Santachiara, whose profile calls to mind a bollard-a nod to the world of seafaring. Designed to be used as a comfortable seat, Bitta houses a cosy inflatable single bed featuring an electrically-powered inflating/deflating system.

ALTEZZA MATERASSO / MATTRESS HEIGHT

48 cm (materasso in PVC gonfiabile / inflatable PVC mattress)

LETTO SINGOLO AUTOGONFIABILE / SINGLE AIRBED

Letto / Bed 95x200 cm





Brando

DESIGNER GIUSEPPE AREZZI

SCHEDA TECNICA / TECHNICAL SHEET 232

Brando è la nuova interpretazione del letto da campo, un prodotto trasformabile dal design elegante e funzionale, realizzato in legno di frassino e tessuto. Grazie al cuscino reclinabile che evoca la comodità dei tradizionali guanciali e all'aspetto di una panca imbottita, Brando si adatta perfettamente a ogni ambiente. Versatile e leggero, può essere utilizzato con facilità sia all'interno che all'esterno, offrendo un equilibrio ideale tra comfort domestico e la libertà di godersi spazi aperti.

Brando is the new interpretation of the camp bed, a transformable product with an elegant and functional design, made from ash wood and fabric. Thanks to its reclining cushion, reminiscent of the comfort of traditional pillows, and its padded bench-like appearance, Brando adapts perfectly to any environment. Versatile and lightweight, it can be easily used both indoors and outdoors, offering the perfect balance between domestic comfort and the freedom to enjoy open spaces.

LETTINO PIEGHEVOLE / FOLDABLE BED

Letto / Bed 70x200 cm

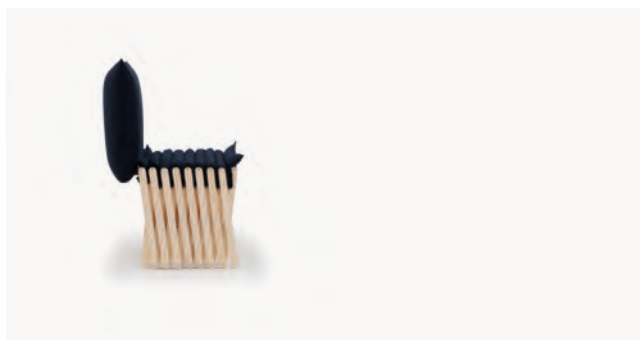
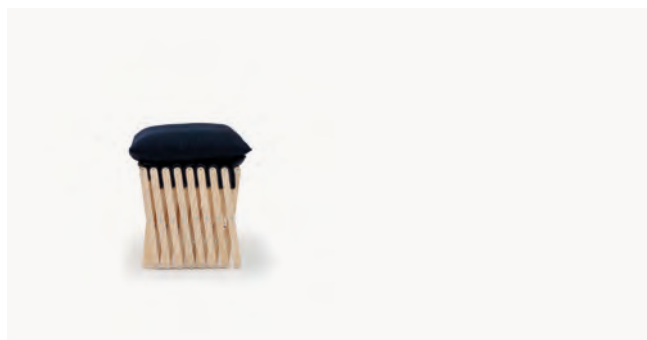







Canispè

DESIGNER GIOVANNI LEVANTI

SCHEDA TECNICA / TECHNICAL SHEET 233

Canispè accoglie, rilassa e invita a vivere momenti di benessere. Ci si può distendere sulla sua superficie, appoggiarsi all'alto schienale, da soli o in compagnia, o cercare quiete e gioco con il proprio cane. All'interno nasconde un morbido cuscino-cuccia, estraibile e utilizzabile liberamente. Canispè celebra la relazione tra persone e animali con una forma morbida e iconica, un luogo intimo dalle molte posture, reso ancora più avvolgente dal dialogo tra tessuti diversi e da una calda esperienza sensoriale.

Canispè welcomes, relaxes, and invites moments of wellbeing. You can stretch out on its surface, rest against its high backrest alone or in company, or share quiet and play with your dog. Inside, it conceals a soft cushion-kennel that can be easily removed and used freely. Canispè celebrates the bond between people and animals through a soft and iconic shape, an intimate space offering multiple postures, made even more embracing by the interplay of different fabrics and a warm sensory experience.

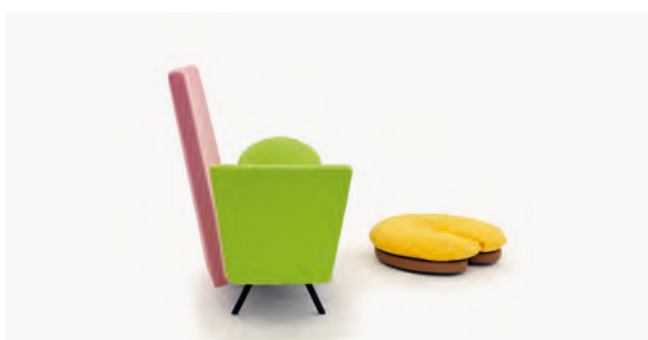



Gilbert & George

DESIGNER DENIS SANTACHIARA

SCHEDA TECNICA / TECHNICAL SHEET 241

Gilbert & George è un grande pouf composto da due elementi che si incastrano alla perfezione dando origine a una linea che suggerisce molteplici possibilità d'uso. All'occorrenza il pouf si trasforma in due sedute indipendenti o in due poltroncine a dondolo, non uguali ma dalla personalità simmetrica e aperta a qualunque evoluzione, proprio come Gilbert & George.

Gilbert & George is a big pouf composed of two elements perfectly fitting together, drawing a line that suggests different uses. If necessary, the ottoman turns into a couple of independent seats or even rocking chairs. Not identical but symmetrical, just like Gilbert & George.





Ipno

DESIGNER FINEMATERIA

SCHEDA TECNICA / TECHNICAL SHEET 248

Solo morbidezza, in un grande abbraccio metaforico e reale, Ipno è una poltroncina priva di parti rigide, un oggetto monomaterico che in pochi secondi si trasforma in un materassino per il riposo. Offre un piano spesso e confortevole che isola dal pavimento e custodisce la sensazione di spazio personale. Richiusa, forma un volume compatto fermato da cinghie; aperta, rivela un microcosmo dedicato al relax che offre il massimo comfort. All'interno contiene un caldo trapuntino. Il rivestimento è sfoderabile e disponibile in vari colori.

Pure softness, in a great embrace both metaphorical and real, Ipno is an armchair with no rigid parts, a single-material object that transforms in seconds into a rest mat. It offers a thick, comfortable surface that insulates from the floor and preserves a sense of personal space. When closed, it forms a compact volume secured by straps; when opened, it reveals a small world devoted to relaxation and maximum comfort. Inside, it holds a warm quilt. The removable cover is available in various colors.

ALTEZZA MATERASSO / MATTRESS HEIGHT

12 cm (materasso in poliuretano / polyurethane mattress)

MATERASSINO CON TRAPUNTA / MATTRESS WITH QUILT

Letto / Bed 70x225 cm



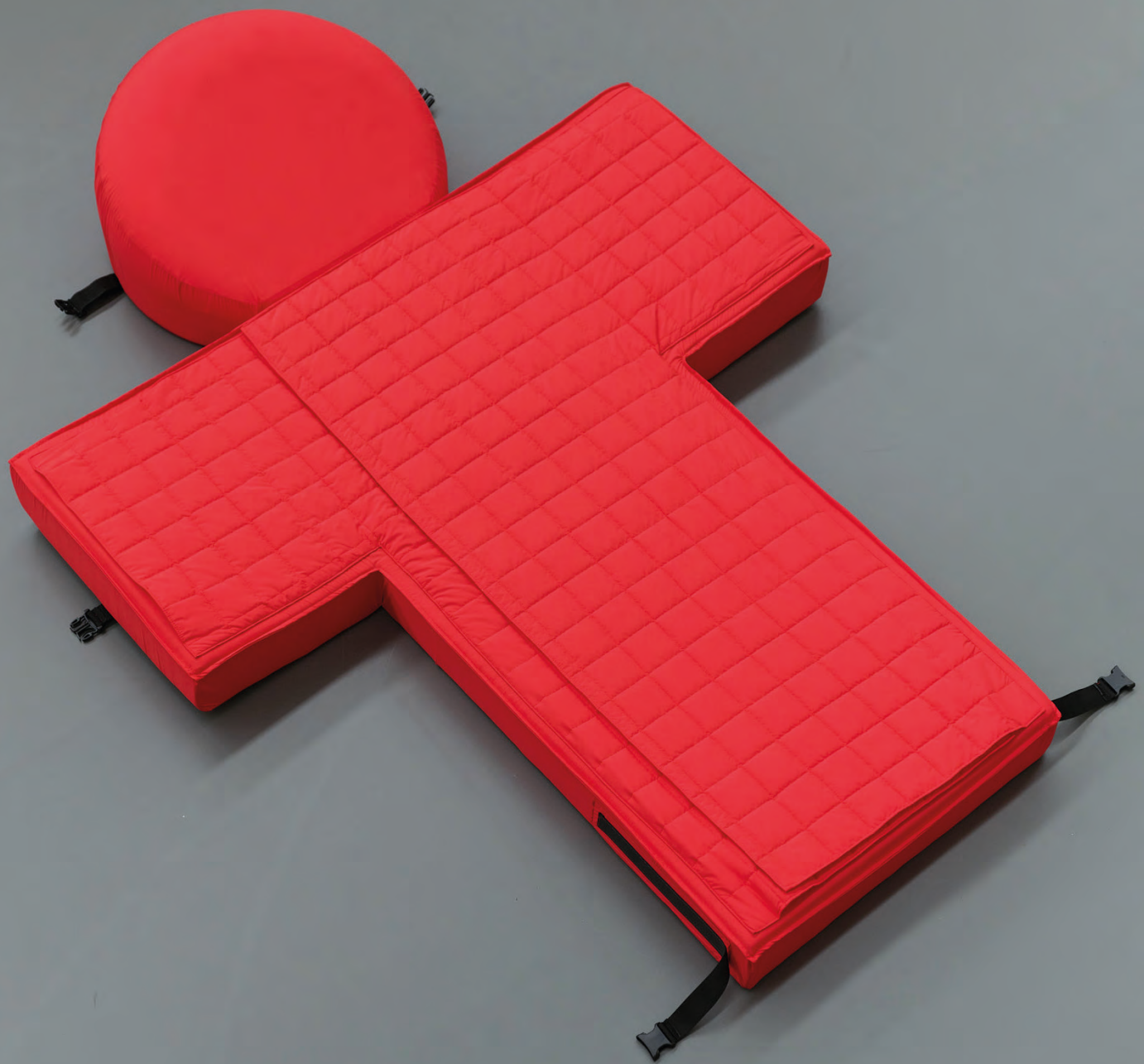

Kai

DESIGNER SAKURA ADACHI

SCHEDA TECNICA / TECHNICAL SHEET 249

Sakura Adachi prosegue la sua esplorazione nelle sedute multifunzione stilizzate con Kai, piccola panca dalla struttura in metallo bianco, seduta e schienale in multistrato rivestito in feltro arancio o giallo che si trasforma in un pratico tavolo da lavoro. Una citazione delle linee essenziali dei vecchi banchi di scuola, capace di integrarsi perfettamente nei molteplici contesti dell'abitare urbano.

Sakura Adachi continues her exploration in the multifunctional stylized seats with Kai, a small bench with a white metal structure, seat and backrest in multilayer covered with orange or yellow felt that turns into a practical work table. A quotation of the essential lines of the old school benches, able to integrate perfectly in the many contexts of urban living.





Lazy Basketball

DESIGNER EMANUELE MAGINI

SCHEDA TECNICA / TECHNICAL SHEET 250

Un elemento d'arredo di design per chi ama il basket e non solo: Lazy Basketball è una seduta con struttura in metallo e schienale in rete sintetica, dalla linea semplice e sinuosa, che si conclude nel suo apice con un divertente canestro colorato. Molto più che una semplice sedia trasformabile, questo arredo di design è ossimoro leggero tra il bisogno di riposo e la voglia di muoversi!

A design piece for basketball lovers and beyond: Lazy Basketball is a seat with a metal frame and synthetic mesh backrest, featuring a simple, flowing line that culminates playfully in a colorful basketball hoop. Much more than a simple convertible chair, this design piece is a lighthearted oxymoron balancing the need for rest with the desire to move!

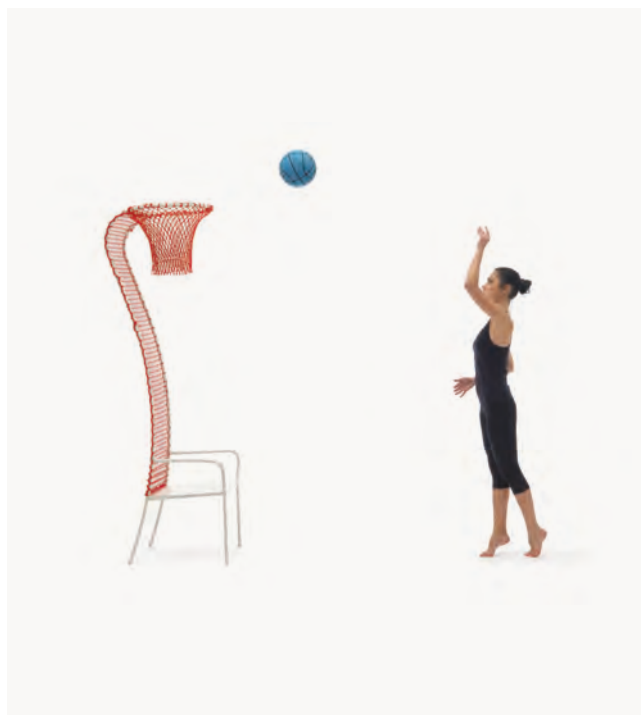



Le Temps de la Communauté

DESIGNER MATALI CRASSET

SCHEDA TECNICA / TECHNICAL SHEET 250

Le Temps de la Communauté è un divano innovativo che trasforma il concetto di arredo in un'esperienza versatile e interattiva. Composto da moduli "tagliati" e riconfigurabili, può adattarsi alle esigenze di chi lo usa. Ogni elemento ha la seduta in tessuto o lana riciclata e i lati in eco-pelle con calamite integrate per la connessione. Ruotando i singoli moduli, possono diventare pouf, ampliando le possibilità compositive. Questa flessibilità rende il divano perfetto per spazi dinamici e creativi. Le Temps de la Communauté non è solo un divano, ma un invito alla convivialità e alla condivisione.

Le Temps de la Communauté is an innovative sofa that re-defines furniture as a versatile, interactive experience. Composed of "cut" modular elements, it can be reconfigured to suit users' needs. Each module features a seat in recycled fabric or wool and sides in eco-leather with built-in magnets for easy connection. By rotating each piece, it can also be used as a pouf, expanding its compositional possibilities. This flexibility makes it ideal for dynamic, creative spaces. Le Temps de la Communauté is not just a sofa, but an invitation to conviviality and sharing.





Campaggi

Maracanà

DESIGNER EMANUELE MAGINI

SCHEDA TECNICA / TECHNICAL SHEET 251

Emanuele Magini, autore di prodotti iconici dal forte impatto emotivo, continua a proporre soluzioni di interior design che superano gli schemi della tradizione ispirandosi a nuove esigenze e nuove gestualità. Maracanà: l'elemento d'arredo trasformabile che invita alla condivisione può essere un divano, un letto matrimoniale e soprattutto un piccolo spalto domestico per eventi di sport, cinema o concerti.

Emanuele Magini, known for his iconic designs with strong emotional impact, continues to create interior solutions that go beyond traditional schemes, inspired by new needs and gestures. Maracanà: a transforming furniture piece that invites sharing it can be a sofa, a double bed, or even a small domestic grandstand for sports events, movies, or concerts.

ALTEZZA MATERASSO / MATTRESS HEIGHT

41 cm (materasso in poliuretano / polyurethane mattress)

LETTO MATRIMONIALE / DOUBLE BED

Letto / Bed 145x200 cm

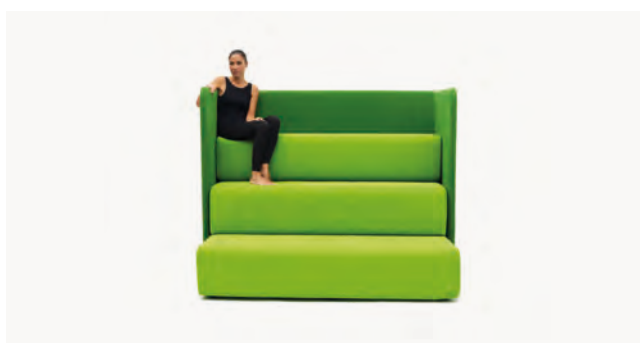
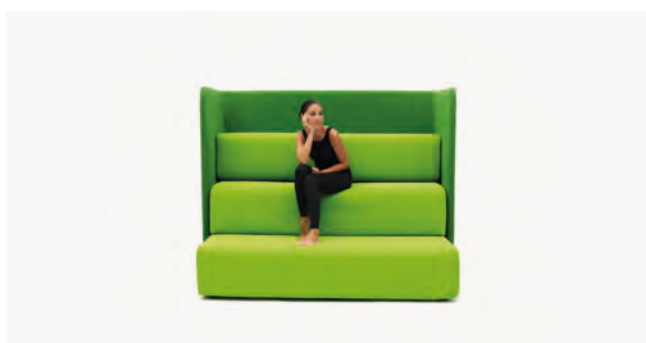



Mehari

DESIGNER DAVIDE BIANCUCCI

SCHEDA TECNICA / TECHNICAL SHEET 252

Originariamente concepita in ambito militare, la safari chair era pensata per essere facilmente smontata e trasportata, unendo un telaio in legno a un rivestimento in canvas leggero e confortevole. Mehari ne riprende lo spirito con un telaio che, grazie alla semplice rotazione della seduta, permette di aprirla, chiuderla o appenderla, adattandosi agli spazi contemporanei. La collezione comprende anche un divanetto a due posti e un ottoman, entrambi pieghevoli e appendibili. Realizzata in frassino verniciato con tessuto in canvas removibile e lavabile, Mehari è ideale per ambienti indoor e outdoor.

Originally conceived for military use, the safari chair was designed to be easily disassembled and transported, combining a simple wooden frame with a lightweight canvas cover for comfort and practicality. Mehari preserves this spirit with a frame that, through a simple rotation of the seat, can be opened, closed, or hung, adapting to contemporary living spaces. The collection also includes a two-seater sofa and an ottoman, both foldable and hangable. Made of varnished ash wood with a removable and washable canvas cover, Mehari is suitable for both indoor and outdoor settings.









Moby

DESIGNER CAMPEGGI DESIGN

SCHEDA TECNICA / TECHNICAL SHEET 253

Quando lo chiudete, Moby vi sembrerà quasi un decoro ricavato nella parete di casa grazie alle sue tinte chiare e alla sua forma molto netta e pulita. Come la famosa balena di Melville di cui questo letto cita il buffo nome, Moby è capiente, robusto e agile. Basterà un piccolo giro sulle ruote per vederlo trasformarsi in un letto comodo e rilassante. Pianetto in legno nobilitato bianco.

When closed, Moby almost looks like a decorative wall element thanks to its light colors and clean, sharp lines. Like Melville's famous whale, from which it takes its playful name, Moby is spacious, sturdy, and agile. Just a simple turn of its wheels transforms it into a comfortable, relaxing bed. White melamine-coated wooden base.

ALTEZZA MATERASSO / MATTRESS HEIGHT

11 cm (materasso in poliuretano / polyurethane mattress)

LETTO SINGOLO / SINGLE BED

Letto / Bed 75x185 cm





A cabinet covered in a red and white vertically striped fabric. A small silver lamp is placed on top of the cabinet.

A wooden bookshelf with several shelves filled with books. A red plastic chair is positioned in front of the bookshelf. The books are arranged in rows, and some are standing upright while others are lying flat. A book titled "Marcello Morandini" is visible on the top shelf.

A square wall-mounted lamp with a warm glow, positioned on the wall between the cabinet and the bookshelf.

A bright red plastic chair with a simple, modern design, positioned in front of the bookshelf.

A patterned tile floor with a repeating geometric and floral design in red, white, and brown.

Pisola

DESIGNER DENIS SANTACHIARA

SCHEDA TECNICA / TECHNICAL SHEET 263

Una poltrona dalle dimensioni ridotte e dal fare domestico, che può contenere al suo interno un materassino gonfiabile. Una pompa elettrica incorporata dà vita in pochi secondi a questa invenzione di Denis Santachiara, capace di stupire ed emozionare. Molto più che una semplice poltroncina letto!

A compact, homey armchair that conceals an inflatable mattress inside. An integrated electric pump brings this invention by Denis Santachiara to life in just a few seconds — a creation designed to surprise and delight. Much more than a simple armchair bed!

ALTEZZA MATERASSO / MATTRESS HEIGHT

20 cm (materasso in PVC gonfiabile / inflatable PVC mattress)

LETTO GONFIABILE / AIRBED

Letto / Bed 83x190 cm

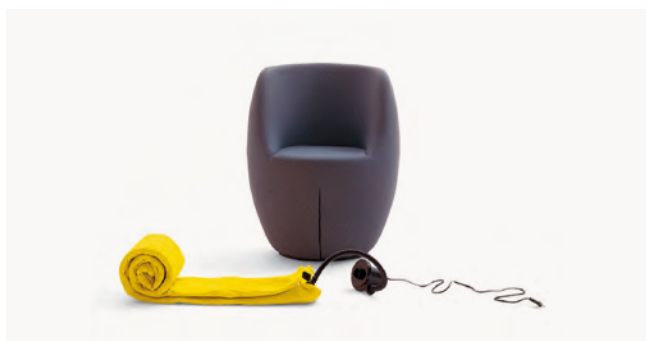



Q.letto

DESIGNER DENIS SANTACHIARA

SCHEDA TECNICA / TECHNICAL SHEET 265

Q.letto di Denis Santachiara è un oggetto d'arredo che si sa trasformare da una funzione minima a una massima: è un cuscino per divani o un pouf. Poi si apre e sorprendentemente contiene un letto da viaggio gonfiabile. È quindi un arredo "riciclabile", trasformabile per eccellenza, pronto ad essere utile in vacanza, da amici, in auto.

Q.letto, designed by Denis Santachiara is a piece of furniture that can turn from a minimal to a maximum function: it can be a sofa or a pouf cushion covered with colored polyester. However, once open you can find a spare inflatable bed inside. It is a "recyclable" and highly convertible piece of furniture, ready to be used on holiday, with friends and in the car.

ALTEZZA MATERASSO / MATTRESS HEIGHT

20 cm (materasso in PVC gonfiabile / inflatable PVC mattress)

LETTO GONFIABILE / AIRBED

Letto / Bed 78x190 cm





Siesta

DESIGNER EMANUELE MAGINI

SCHEDA TECNICA / TECHNICAL SHEET 267

Una seduta estremamente lineare ma inaspettata, che gioca con l'iconografia tradizionale della panchina urbana e la innesta sul simbolo più potente del relax totale, un'amaca tropicale: il gesto di lasciarsi andare trova una nuova espressione ancora più libera, divertente e confortevole in questo progetto.

An extremely linear yet unexpected seat that plays with the traditional iconography of the urban bench and combines it with the most powerful symbol of total relaxation, a tropical hammock: the act of letting go finds a new, freer, more playful and comfortable expression in this project.

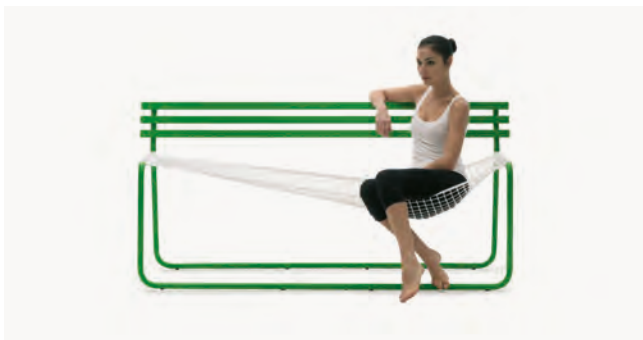



Tutù

DESIGNER CAMPEGGI DESIGN

SCHEDA TECNICA / TECHNICAL SHEET 273

All'insegna della flessibilità e della generosità, Tutù si presenta nella sua linea essenziale morbidamente squadrata e nella funzione multipla di pouf dalle dimensioni generose, rivestito con una pratica housse che arriva fino a terra. Questo pouf trasformabile è un piccolo protagonista e, allo stesso tempo, una grande risorsa per ogni ambiente della casa. La sua versatilità è tutta racchiusa in un metro quadrato.

Tutù presents itself in an essential multifunctional softly squared style that can become a large ottoman, a single bed, a shelf, covered by a practical liner that reaches down to the ground. It could be placed anywhere in the house, versatile in just a square meter.

ALTEZZA MATERASSO / MATTRESS HEIGHT

11 cm (materasso in poliuretano / polyurethane mattress)

SEDILE LETTO / SMALL SINGLE SIZE BED POUF

Letto / Bed 75x185 cm





Underdog

DESIGNER LORENZO DAMIANI

SCHEDA TECNICA / TECHNICAL SHEET 274

Underdog è un progetto contemporaneo e anticonvenzionale che si mostra nella sua essenzialità: un letto o seduta pieghevole, trasformabile in un grande trolley con ruote extra large, facile da spostare ovunque. L'estetica è raw e diretta, con una struttura in metallo e un piano in cinghie elastiche. Il materasso in poliuretano espanso, il cavalletto ispirato al ciclismo e le cromie industriali raccontano un arredo autentico, che parla e soprattutto risponde.

Underdog is a contemporary and unconventional project that reveals itself in pure simplicity: a foldable bed or seat that transforms into a large trolley with extra-large wheels, easy to move anywhere. Its aesthetic is raw and straightforward, featuring a metal frame and an elastic strap base. The polyurethane foam mattress, bicycle-inspired stand, and industrial color palette express an authentic piece of furniture that speaks and, above all, responds.

ALTEZZA MATERASSO / MATTRESS HEIGHT

11 cm (materasso in poliuretano / polyurethane mattress)

LETTO NOMADE / NOMADIC BED

Letto / Bed 78x193 cm





Yaki

DESIGNER CAMPEGGI DESIGN

SCHEDA TECNICA / TECHNICAL SHEET 275

Il pouf letto Yaki è compatto e leggero, facile da trasportare di stanza in stanza o di casa in casa: la soluzione pronta all'uso per tutte le occasioni in cui serve un angolo di riposo in più. Versatile e disinvolto, questo pouf di design è perfetto per trasformarsi in un complemento d'arredo per ambienti eleganti o disimpegnati: nel salotto buono, nella casa vacanze o nel minialloggio per studenti.

The Yaki sleeper pouf is compact and lightweight, easy to move from room to room or from one home to another: a ready-to-use solution whenever an extra resting space is needed. Versatile and effortless, this design pouf easily becomes a furnishing accessory suited to both elegant and informal interiors, from the formal living room to a holiday home or a compact student apartment.

ALTEZZA MATERASSO / MATTRESS HEIGHT

10 cm (materasso in poliuretano / polyurethane mattress)

POUF LETTO / SINGLE BED POUF

Letto / Bed 75x198 cm





Zoom

DESIGNER GIULIO MANZONI

SCHEDA TECNICA / TECHNICAL SHEET 280

Il pouf trasformabile Zoom dilata lo spazio nello stile di Giulio Manzoni: è una seduta complementare di dimensioni contenute e dall'aspetto versatile e senza tempo, ma la scocca portante in resina e poliuretano espanso contiene un vero letto matrimoniale. Come dare vita alla trasformazione? È sufficiente azionare il gonfiatore elettrico incorporato *et voilà* ecco creato un nuovo, comodissimo e generoso angolo di riposo. Il rivestimento del pouf letto Zoom è in lycra colorata.

The Zoom convertible pouf expands space in Giulio Manzoni's signature: it's a compact, versatile, and timeless seat whose resin and polyurethane foam shell conceals a real double bed. How does the transformation happen? Simply activate the built-in electric inflator *et voilà* a new, spacious, and comfortable resting area appears. The Zoom pouf bed comes with a colorful lycra cover.

ALTEZZA MATERASSO / MATTRESS HEIGHT

48 cm (materasso in PVC gonfiabile / inflatable PVC mattress)

LETTO MATRIMONIALE GONFIABILE / DOUBLE SIZE AIRBED

Letto / Bed 140x200 cm





Vico Collection



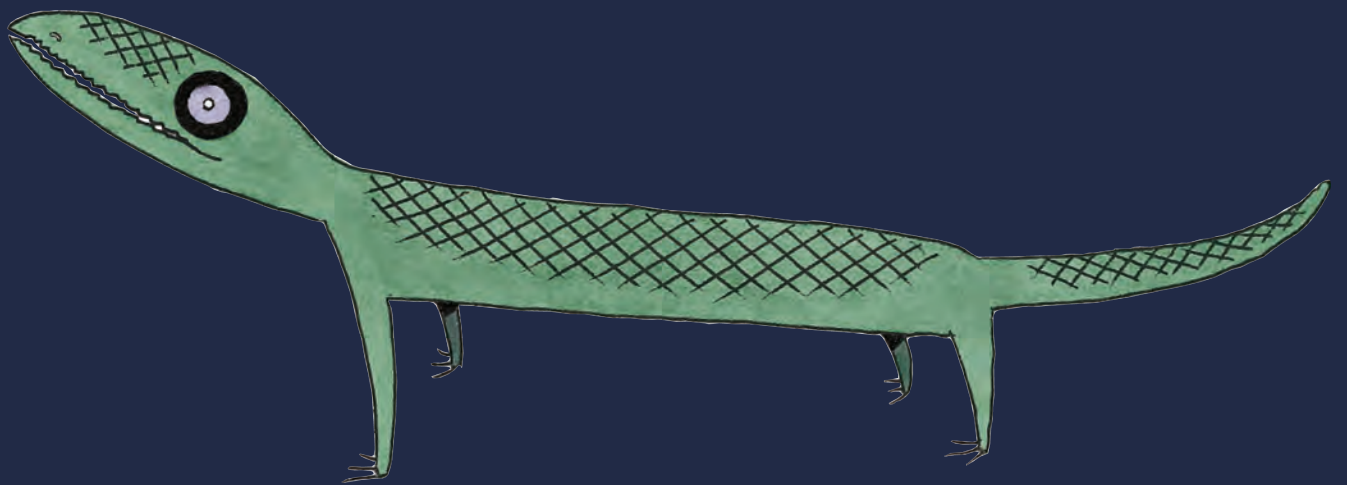

Vico Collection

Broomstick Uno



204 Express



206 Moma



208

Oblò



210 Ospite



214 Piccy



218

Vico Collection è il progetto di riedizione di tutti i prodotti trasformabili nati dalla collaborazione e dall'amicizia tra Claudio Campeggi e Vico Magistretti. La collezione completa include 18 oggetti trasformabili progettati da Vico e prodotti da Campeggi tra la metà degli anni '90 e la metà degli anni 2010. Ogni prodotto sarà rieditato e presentato gradualmente nel corso dei prossimi anni. Il primo rilascio include cinque oggetti: l'appendiabiti pieghevole Broomstick Uno, la libreria mobile Moma, il divano-letto Oblò, il letto-divano Ospite e la sedia pieghevole Piccy.

Vico Collection is a re-edition project featuring all the multifunctional products born from the collaboration and friendship between Claudio Campeggi and Vico Magistretti. The complete collection consists of 18 multifunctional pieces designed by Vico and produced by Campeggi between the mid-1990s and the mid-2010s. Each product will be edited, re-released, and gradually introduced over the coming years. The first release includes five objects: the foldable coat rack Broomstick Uno, the mobile bookcase Moma, the sofa-bed Oblò, the bed-sofa Ospite, and the foldable chair Piccy.







Broomstick Uno

DESIGNER VICO MAGISTRETTI

SCHEDA TECNICA / TECHNICAL SHEET 232

Broomstick Uno è un appendiabiti richiudibile in faggio naturale. È un oggetto dalla grammatica elementare: la sua struttura si basa sulla combinazione di elementi di legno a sezione costante che rimandano, come suggerisce il nome, alla forma dei manici di scopa. È la riedizione dell'appendiabiti Tenorio della famiglia di prodotti Broomstick progettata da Vico Magistretti nel 1979 e prodotta da Alias.

Broomstick Uno is a foldable coat rack made of natural beechwood. It is an object with an elementary design: its structure is based on the combination of wood elements with a constant cross-section, reminiscent, as the name suggests, of broom handles. It is the reissue of the Tenorio coat rack from the Broomstick product family, designed by Vico Magistretti in 1979 and produced by Alias.





Express

DESIGNER VICO MAGISTRETTI

SCHEDA TECNICA / TECHNICAL SHEET 238

Express è il divano a due, tre o quattro posti con doppia fodera bordata con profili in gros grain. Firmato dal designer Vico Magistretti, è rivestito in tessuto disponibile in vari colori e si completa con comodissimi cuscini poggiatesta. Un divano contemporaneo, che reinterpreta in modo giocoso e creativo il rigore stilistico di un design senza tempo.

Express is a two, three or four-seater sofa featuring a double removable cover trimmed with grosgrain piping. Designed by Vico Magistretti, it is upholstered in fabric available in various colors and comes with ultra-comfortable lumbar cushions. A contemporary sofa that playfully and creatively reinterprets the stylistic rigor of timeless design.





Moma

DESIGNER VICO MAGISTRETTI

SCHEDA TECNICA / TECHNICAL SHEET 254

Moma è una libreria configurabile in faggio evaporato cerato che non necessita di fissaggio a muro. È la riedizione dello scaffale presentato da Vico Magistretti al concorso “International competition for low cost furniture design” indetto dal MoMA di New York nel 1948. Moma è il secondo progetto, dopo la poltroncina Piccy, a ricevere il marchio “Vico Magistretti Original Design”, scelto dalla Fondazione Vico Magistretti per autenticare le riedizioni condotte nel rispetto dello spirito originario.

Moma is a configurable bookshelf made of steamed beechwood that does not require wall mounting. It is the reissue of the shelf presented by Vico Magistretti in the ‘International Competition for Low-Cost Furniture Design’ organized by the MoMA in New York in 1948. Moma is the second project, after the Piccy armchair, to receive the ‘Vico Magistretti Original Design’ brand, chosen by Fondazione Vico Magistretti to authenticate reissues made in accordance with the original spirit.





Oblò

DESIGNER VICO MAGISTRETTI

SCHEDA TECNICA / TECHNICAL SHEET 258

Oblò è un divano trasformabile in letto singolo, letto matrimoniale e chaise longue; nessuna forma prevale sull'altra. Ideato con la freschezza dell'immaginazione di un fanciullo, Oblò può essere completamente personalizzato nell'accostamento dei colori oppure richiesto nella combinazione cromatica "solare" scelta da Vico Magistretti (struttura e schienale rosso, cuscino giallo).

Oblò is a sofa which can be converted into a single bed, double bed, and chaise lounge; no one form prevails over the others. Designed with the freshness of a child's imagination, Oblò can be fully customized in terms of color combinations or requested in the "sunny" color scheme chosen by Vico Magistretti (red frame and backrest, yellow cushion).

ALTEZZA MATERASSO SINGOLO / SINGLE MATTRESS HEIGHT

20 cm (materasso in poliuretano / polyurethane mattress)

ALTEZZA MATERASSO DOPPIO / DOUBLE MATTRESS HEIGHT

10 cm (materasso in poliuretano / polyurethane mattress)

DIVANO LETTO SINGOLO / SINGLE BED

Letto / Bed 68x202 cm

DIVANO LETTO MATRIMONIALE / DOUBLE BED

Letto / Bed 136x202 cm









Ospite

DESIGNER VICO MAGISTRETTI

SCHEDA TECNICA / TECHNICAL SHEET 261

Ospite è un letto-divano pieghevole, con struttura in acero naturale e rivestimenti in cotone e lino naturale. Da divanetto a letto d'emergenza e viceversa, Ospite è un trasformabile dall'immagine volutamente discreta. Ispirato ad una branda militare da campo, Ospite si ripiega con semplici gesti in un oggetto dal minimo ingombro.

Ospite is a foldable bed-sofa with a natural maple wood frame and coverings in natural cotton and linen. From a small sofa to an emergency bed and vice versa, Ospite is a multifunctional piece with a deliberately discreet appearance. Inspired by a military field cot, Ospite folds easily into a compact object with minimal bulk.

LETTINO PIEGHEVOLE / FOLDING BED

Letto / Bed 77x190 cm









Piccy

DESIGNER VICO MAGISTRETTI

SCHEDA TECNICA / TECHNICAL SHEET 262

Piccy è una poltroncina pieghevole con struttura in faggio evaporato e seduta in tela; la finitura della ferramenta è in ferro micaceo. Riedizione della poltroncina disegnata da Vico Magistretti e prodotta inizialmente dalla ditta Fumagalli di Meda a partire dalla seconda metà degli anni '40. Viene esposta nella mostra R.I.M.A. del 1946 e alla VIII Triennale del 1947, dove vince la Medaglia di Bronzo. Piccy è il primo progetto con il marchio "Vico Magistretti Original Design", scelto dalla Fondazione Vico Magistretti per autenticare le riedizioni condotte nel rispetto dello spirito originario.

Piccy is a foldable armchair with a steamed beechwood frame and a canvas seat; the hardware finish is in micaceous iron. It is a reissue of the armchair designed by Vico Magistretti and initially produced by the Fumagalli company of Meda starting from the second half of the 1940s. It was exhibited at the R.I.M.A. exhibition in 1946 and at the VIII Triennale in 1947, where it won the Bronze Medal. Piccy is the first project with the 'Vico Magistretti Original Design' brand, chosen by Fondazione Vico Magistretti to authenticate reissues made in accordance with the original spirit.





**Le cose che non cambiano sono
destinate a inaridirsi, solo quelle
in grado di cambiare non muoiono.**

**Things that do not change are
destined to wither; only those
capable of change do not die.**

Steven Guarnaccia



“Ho iniziato a lavorare con Campeggi grazie a *Italo Lupi*. Italo e io avevamo collaborato per diversi anni ad *Abitare e Domus*, e fu lui a invitarmi a realizzare alcune illustrazioni per i materiali dell'*Aspen Design Conference* (le maschere della *Commedia dell'Arte* e l'ingresso alla serata di chiusura della conferenza) nell'anno in cui il tema era il design italiano. Per tre anni avevo realizzato un disegno mensile per la pagina dell'indice di *Metropolitan Home*, satirizzando i modi in cui viviamo le nostre case e i nostri arredi. La rivista mi aveva anche mandato al *Salone del Mobile di Milano* come visual journalist. Italo propose di fare qualcosa di simile (ma su una scala molto più ampia) per *Abitare*. Durante un pranzo da *Florent*, la tavola calda francese dietro l'angolo rispetto al mio studio nel Meat Market, Italo mi disse che voleva fare di *Abitare* il *New Yorker* delle riviste di interior design. Accanto alla splendida fotografia architettonica che era un tratto distintivo di *Abitare*, Italo desiderava aggiungere un elemento di arguzia visiva. Avevamo già collaborato a diversi progetti al di fuori di *Abitare* e, quando Campeggi, con i suoi arredi giocosi e trasformabili, divenne uno dei clienti di Italo, mi chiese di illustrare la copertina. L'illustrazione, al posto della fotografia, rappresentava una rottura radicale rispetto al linguaggio visivo tradizionale dei cataloghi di arredamento. Ma Campeggi non era allora (e non è tuttora) un'azienda di arredamento tradizionale. Ha sempre dato a designer lungimiranti l'opportunità di creare arredi insolitamente colorati e trasformabili, capaci di mettere in discussione le convenzioni del design contemporaneo. Nonostante la

prematura scomparsa di *Claudio Campeggi* e, qualche anno più tardi, la morte di *Italo Lupi*, il rapporto creativo con Campeggi è proseguito con continuità, rafforzandosi nel tempo. Il desiderio di Campeggi di aprire nuove strade (e di sollevare qualche sopracciglio) è rimasto intatto, e la copertina di quest'anno prende la forma di una striscia a fumetti che rende omaggio alle strisce fantasy dei primi del Novecento, come *Little Nemo in Slumberland* di *Winsor McKay* e *Quadrattino* di *Antonio Rubino*. Sono sempre stato in dialogo con splendidi oggetti di design grazie al mio rapporto con Italo e Claudio. Un dialogo che è continuato e si è rinnovato attraverso confronti costanti e attraverso gli arredi sempre sorprendenti che Campeggi continua a produrre.”

“I first began working with Campeggi through *Italo Lupi*. Italo and I had worked together for a number of years at *Abitare* and *Domus*, and I was invited by him to create some illustrations for materials for the *Aspen Design Conference* (*Commedia Dell'Arte* masks and an entrance to the end-of-conference) the year that the conference theme was Italian Design. I had made a monthly drawing for three years for the contents page of *Metropolitan Home* magazine, satirizing the ways we live in our homes and with our furniture. They had also sent me to the *Milan Salone del Mobile* as a visual journalist. Italo proposed doing something similar (but on a much grander scale) for *Abitare*. Over lunch at *Florent*, the French diner around the corner from my studio in the Meat Market, Italo told me that he wanted to make *Abitare* the *New Yorker* of interior design magazines. Along with the beautiful architectural photography that was a hallmark of *Abitare*, Italo wanted to add an element of visual wit. We had collaborated on a number of non-*Abitare* projects, and when Campeggi, with its playful, shape-shifting furniture became one of Italo's clients, he asked me to illustrate the cover. Illustration, rather than photography, was a radical departure from the traditional furniture catalog visual language. But Campeggi wasn't then (and isn't today) a traditional furniture company. They consistently gave forward-thinking designers the opportunity to create unusually colorful, transformable furniture that challenged the norms of contemporary design. Despite the premature passing of *Claudio Campeggi*, and the death of *Italo Lupi* a few years later, the creative relationship with Campeggi has continued with consistency, growing ever stronger over time. Campeggi's desire to break new ground (and raise a few eyebrows) has remained intact, with this year's cover in the form of a comic strip that pays homage to early 20th century fantasy strips, such as *Winsor McKay's Little Nemo In Slumberland* and *Antonio Rubino's Quadrattino*. I had always been in dialogue with wonderful design objects through my relationship with Italo and Claudio. That relationship has continued and been renewed through regular dialogues and the ever-surprising furniture that Campeggi produces.”

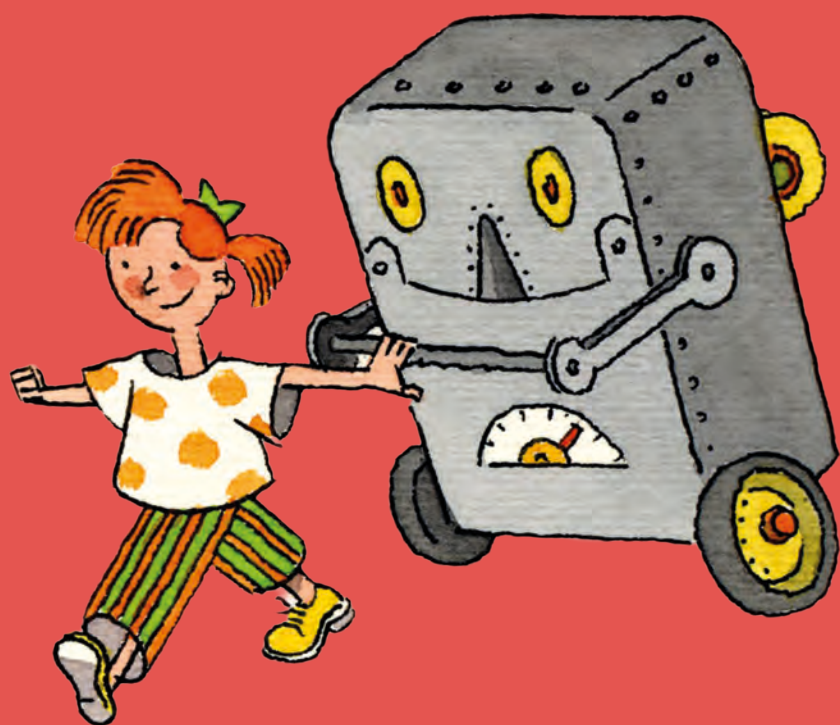

ABC	226	Cy	235
Acca	226	Dadà	236
Amour	227	Dandy	236
Aoy	228	Di-Tra-Verso	237
Babu	230	Dudù	237
Bibi	230	Express	238
Big-Bag	231	Fefè	238
Bitta	231	Flower	239
Brando	232	Gilbert & George	241
Broomstick Uno	232	Giù	241
Bye	233	Go	242
Canispè	233	Go.up	244
Ciac	234	Ho	246
Country.club	234	Holi	247
Commedia	235	Iboo	248
		Ipno	248
		Istante	249
		Kai	249
		Lazy Basketball	250

Le Temps de la Communauté		Pit	263
Lowe	250	Plan	264
Maracanà	251	Q.letto	265
Matrix	251	Quilt	265
Mehari	252	Ritz	266
Micia	252	Saiwa	267
Moby	253	Siesta	267
Moma	253	Sky	268
Nuvò	254	Snob	271
O.scià	254	Soft	272
Oa	255	Tango	272
Oblò	257	Tip-Tap	273
Olo	258	Tutù	273
Oops	259	Underdog	274
Ospite	261	Virgola	274
Piazzagrande	261	Yaki	275
Piccy	262	Zazà	276
Pisola	262	Zoe	280
	263	Zoom	280

Struttura Struttura in legno e acciaio con cinghie elastiche. **Meccanismo** Meccanismo del letto in acciaio, verniciatura a polveri epossidiche, meccanismo con binari, supporto per dormire in MDF. **Imbottitura** Poliuretano espanso senza CFC a quote differenziate e ovatta poliestere. **Materasso** Materasso in poliuretano espanso H 8 cm a densità 25 kg/m³. **Sfoderabilità** Divano completamente sfoderabile.

Structure Wooden and steel frame with elastic webbing. **Bed mechanism** Steel bed mechanism with epoxy powder coating and smooth sliding rails; MDF sleeping base. **Padding** CFC-free polyurethane foam with differentiated densities, covered with polyester wadding. **Mattress** Polyurethane foam mattress, 8 cm thick (density 25 kg/m³). **Removable covers** Fully removable upholstery.

Divano angolare sx/dx trasformabile in letto singolo, gemellare, matrimoniale / Left/right corner sofa with single, twin or double bed
82x200 cm
164x200 cm

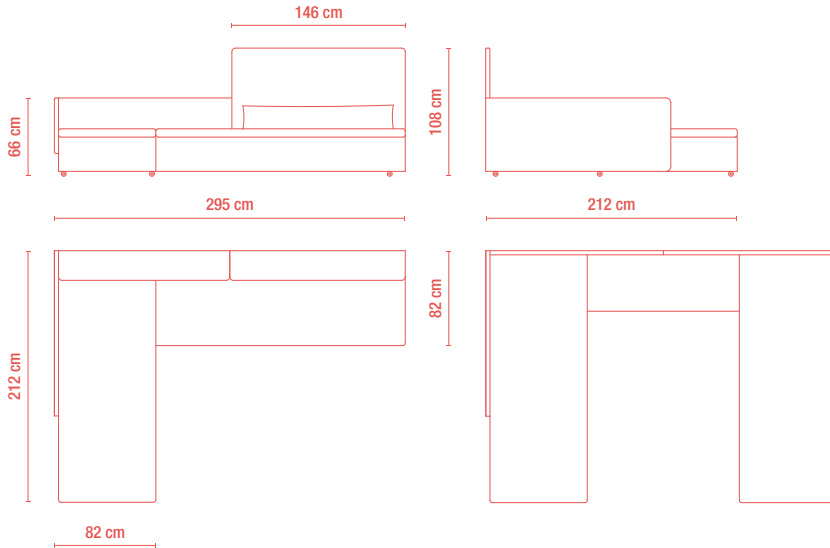

Profondità seduta / Seating depth 55 cm
Altezza seduta / Seat height 40 cm

Altezza materasso / Mattress height 8 cm

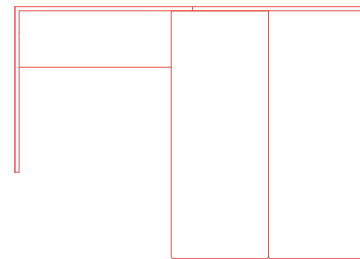

Acca

DESIGNER GIULIO MANZONI

Struttura Struttura in acciaio rivestita in poliuretano espanso e fibra. **Meccanismo** Meccanismo del letto in acciaio, verniciatura a polveri epossidiche, meccanismo con apertura dei braccioli tramite ruote e ribaltamento dello schienale. **Imbottitura** Poliuretano espanso senza CFC a quote differenziate e ovatta poliestere. **Sfoderabilità** Poltrona completamente sfoderabile.

Structure Steel frame upholstered in polyurethane foam and fibre. **Bed mechanism** Steel bed mechanism with epoxy powder coating and armrest opening system on castors with backrest fold-down. **Padding** CFC-free polyurethane foam with differentiated densities, covered with polyester wadding. **Removable covers** Fully removable upholstery.

Poltrona letto /
Chair bed
75x204 cm

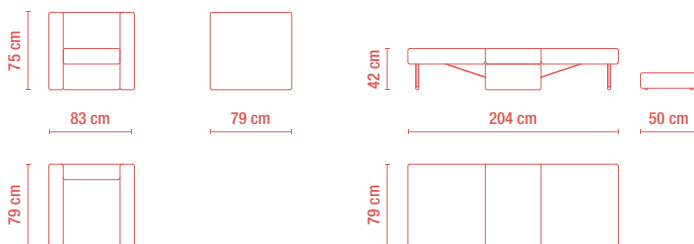

Profondità seduta / Seating depth 55 cm
Altezza seduta / Seat height 40 cm

Altezza materasso / Mattress height
12 cm (materasso in poliuretano / polyurethane mattress)

Struttura Inserto in acciaio rivestito in poliuretano espanso e fibra. **Meccanismo** Meccanismo del letto in acciaio, verniciatura a polveri epossidiche, meccanismo con apertura sincronizzata mediante ribaltamento della spalliera, supporto per dormire in doghe larghe in faggio stratificato anti affossamento. **Imbottitura** Poliuretano espanso senza CFC a quote differenziate e ovatta poliestere. **Piedino** Piedino in legno di noce H 8 cm. **Materassi** Materasso in poliuretano espanso H 19 cm a una densità 25 kg/m³; Materasso a molle H 19 cm composto da Molleggio Bonnel 2.0 e lastra di espanso FE21 su entrambi i lati; Materasso in memory foam (o schiuma in lattice) H 19 cm. **Sfoderabilità** Divano completamente sfoderabile.

Structure Steel insert upholstered in polyurethane foam and fibre. **Bed mechanism** Steel bed mechanism with epoxy powder coating and synchronized opening system with backrest tilt; laminated beech wide slats anti-sag sleeping base. **Padding** CFC-free polyurethane foam with differentiated densities, covered with polyester wadding Feet Walnut wood feet, 8 cm high. **Mattresses** Polyurethane foam mattress, 19 cm thick (density 25 kg/m³); Spring mattress, 19 cm thick, with Bonnel 2.0 spring system and FE21 foam layer on both sides; Memory foam (or latex foam) mattress, 19 cm thick. **Removable covers** Fully removable upholstery.

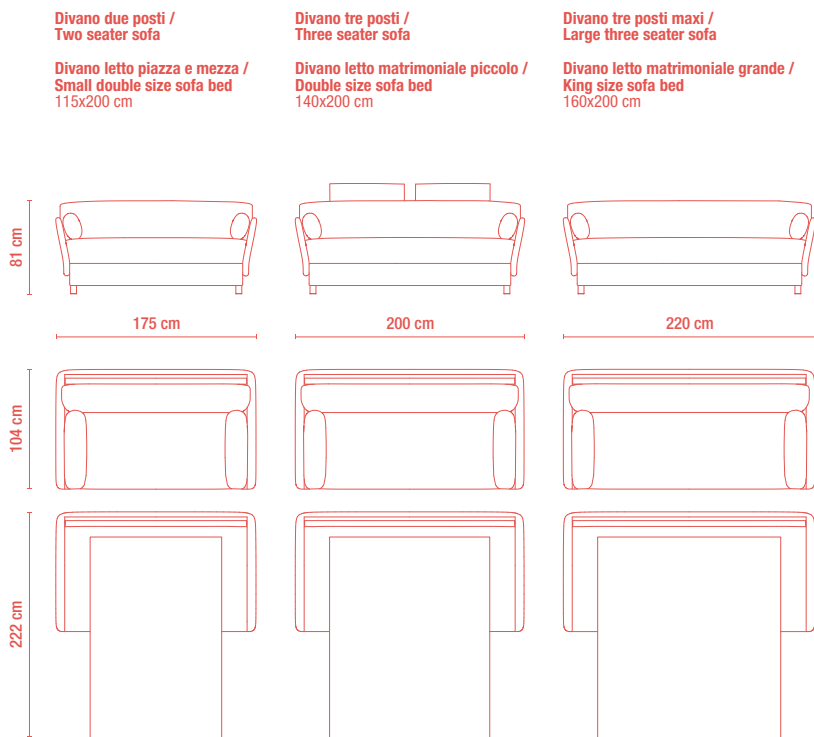

Profondità seduta / Seating depth 58 cm
Altezza seduta / Seat height 49 cm

Altezza materasso / Mattress height
19 cm (materasso a molle / spring mattress)
19 cm (materasso in poliuretano / polyurethane mattress)
19 cm (materasso in memory foam / memory foam mattress)

Disponibile in versione fissa / Available sofa without bed

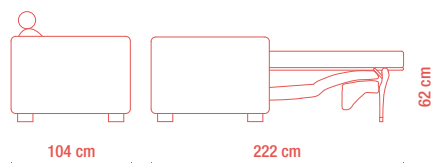

Poggiatesta / Headrest

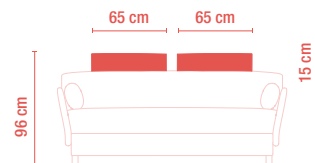

Struttura Inserto in legno rivestito in poliuretano espanso e fibra. **Meccanismo** Meccanismo del letto in acciaio, verniciatura a polveri epossidiche, meccanismo con sistema di apertura a sollevamento frontale a due tempi, supporto per dormire in maglia d'acciaio elettrosaldata. **Imbottitura** Poliuretano espanso senza CFC a quote differenziate e ovatta poliestere. **Piedino** Piedino in acciaio cromato (o brunito su richiesta) H 13 cm. **Materasso** Materasso a molle H 12 cm composto da Molleggio Bonnel 2.0, feltro morbido 1200gr/m³ su entrambi i lati, lastra di espanso FE21 su un lato. **Sfoderabilità** Divano completamente sfoderabile.

Structure Wooden insert upholstered in polyurethane foam and fibre. **Bed mechanism** Steel bed mechanism with epoxy powder coating and two-stage front lifting opening system; electro-welded steel mesh sleeping base. **Padding** CFC-free polyurethane foam with differentiated densities, covered with polyester wadding. **Feet** Chrome-plated steel feet (or burnished steel on request), 13 cm high. **Mattress** Spring mattress, 12 cm thick, with Bonnel 2.0 spring system, soft felt 1200 g/m³ on both sides, and FE21 foam layer on one side. **Removable covers** Fully removable upholstery.

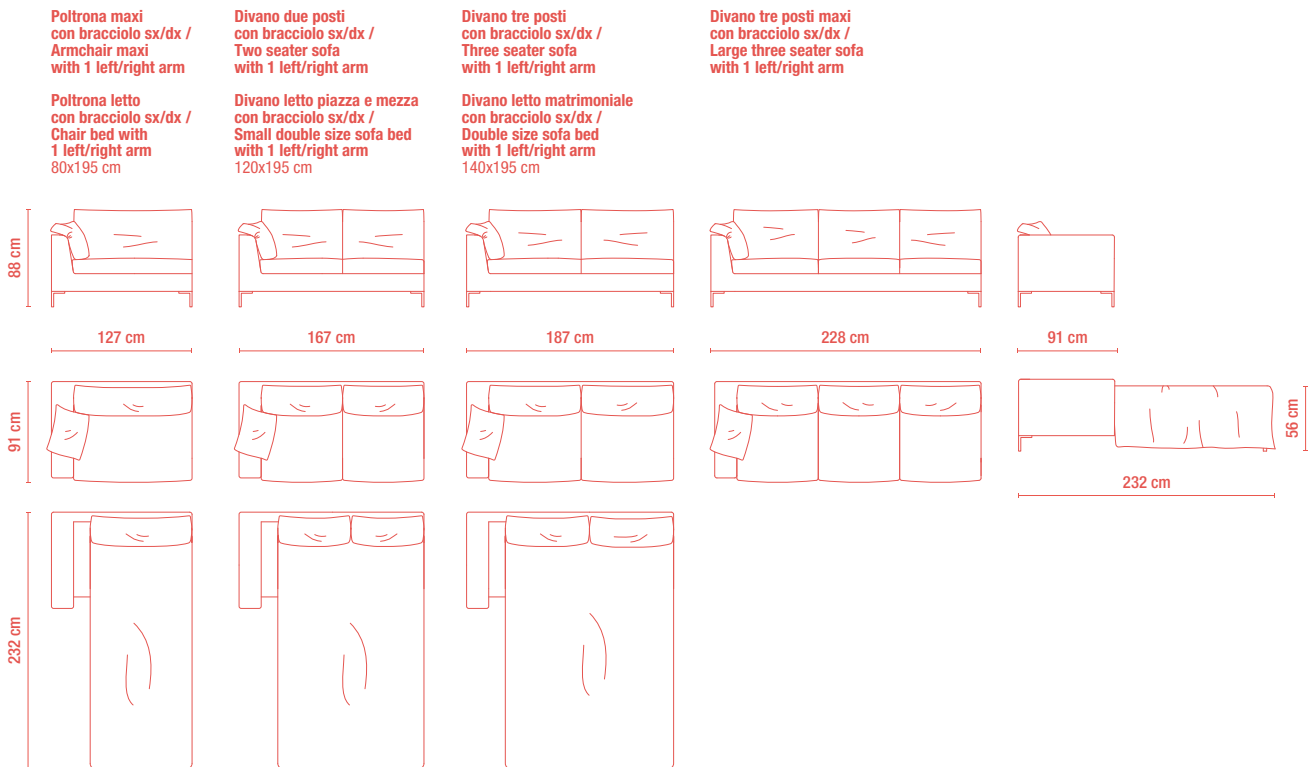
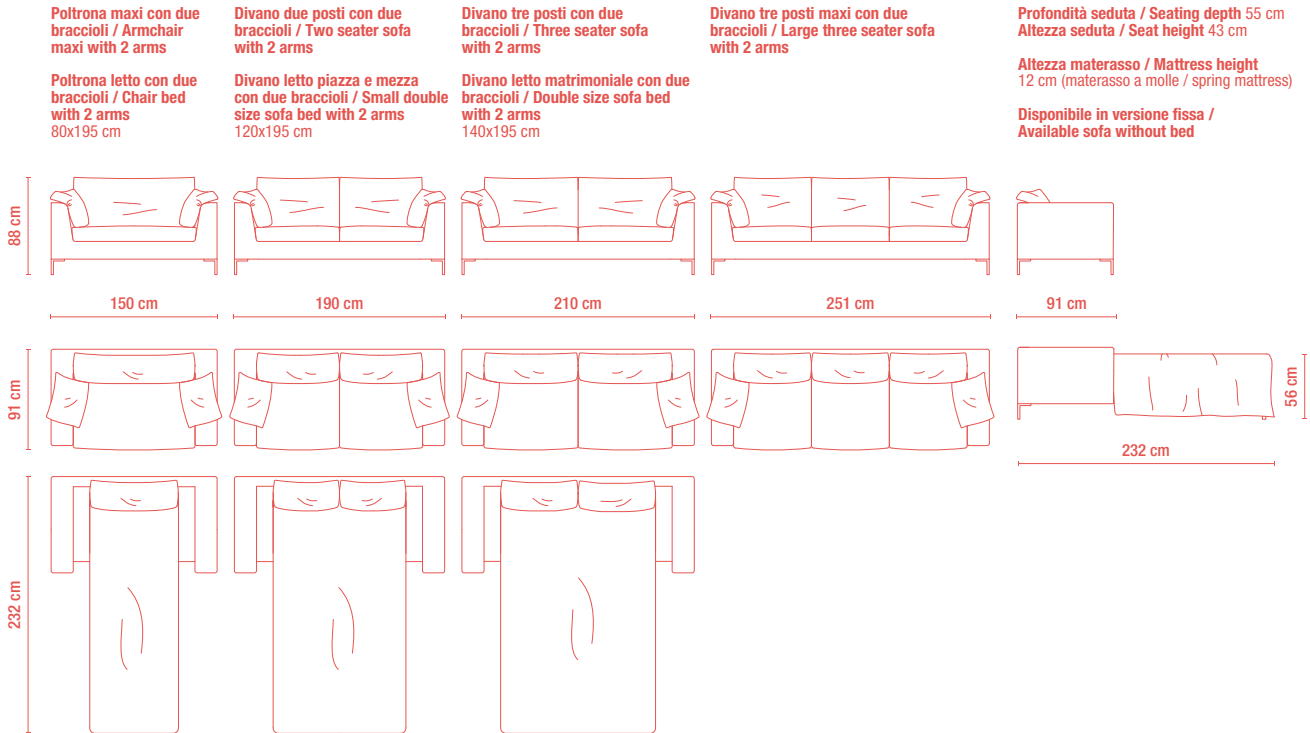

**Poltrona maxi
senza braccioli /
Armchair maxi
without arms**

**Poltrona letto
senza braccioli /
Chair bed
without arms
80x195 cm**

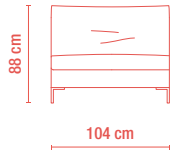

**Divano due posti
senza braccioli /
Two seater sofa
without arms**

**Divano letto piazza e mezza
senza braccioli /
Small double size sofa bed
without arms
120x195 cm**

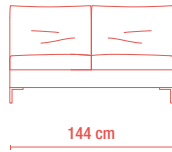

**Divano tre posti
senza braccioli /
Three seater sofa
without arms**

**Divano letto matrimoniale
senza braccioli /
Double size sofa bed
without arms
140x195 cm**

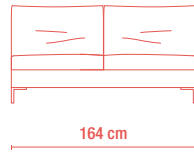

**Divano tre posti maxi
senza braccioli /
Large three seater sofa
without arms**

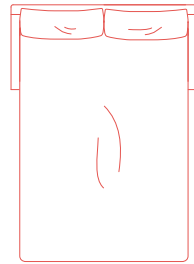
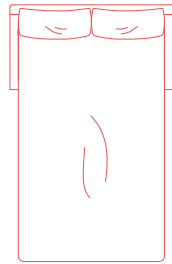
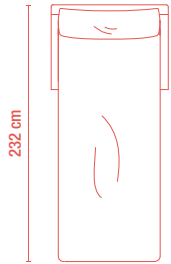
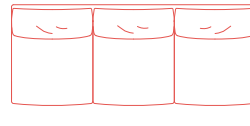
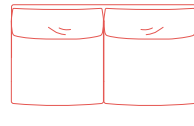
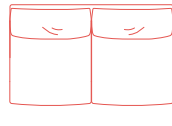
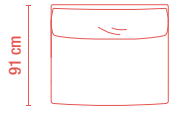
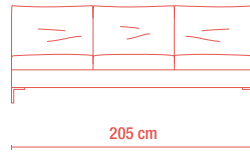

**Poltrona lunga con due braccioli /
Chaise longue with 2 arms**

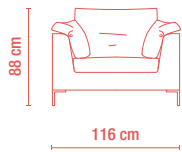

**Poltrona lunga con bracciolo sx/dx /
Chaise longue with 1 left/right arm**

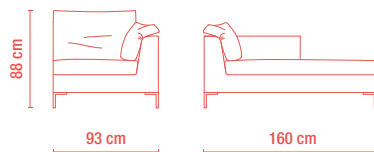

**Poltrona lunga senza braccioli /
Chaise longue without arms**

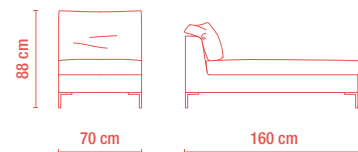

**Sedile /
Ottoman**

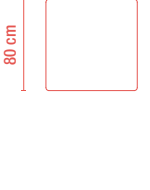
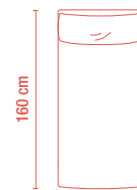
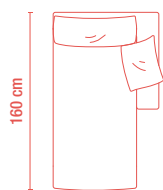
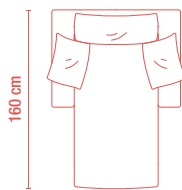
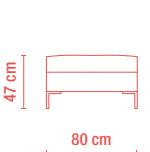

Struttura Struttura in acciaio rivestita in poliuretano espanso e fibra. **Mec- canismo** Meccanismo del letto in acciaio, verniciatura a polveri epossidiche, meccanismo con apertura frontale a piani sovrapposti, supporto per dormire in maglia d'acciaio elettrosaldato. **Imbottitura** Poliuretano espanso senza CFC a quote differenziate e ovatta poliestere. **Materasso** Materasso in poliuretano espanso H 10 cm a una densità 25 kg/m³. **Sfoderabilità** Poltrona completamente sfoderabile.

Structure Steel frame upholstered in polyurethane foam and fibre. **Bed mechanism** Steel bed mechanism with epoxy powder coating and front-opening mechanism with overlapping panels; electro-welded steel mesh sleeping base. **Padding** CFC-free polyurethane foam with differentiated densities, covered with polyester wadding. **Mattress** Polyurethane foam mattress, 10 cm thick (density 25 kg/m³). **Removable covers** Fully removable upholstery.

Poltrona letto /
Chair bed
75x198 cm

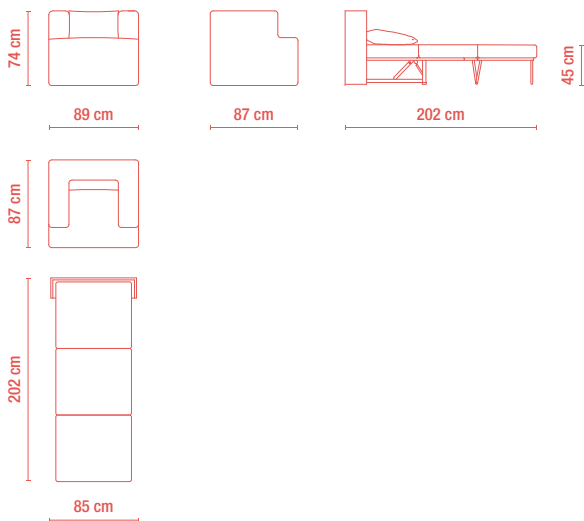

Profondità seduta / Seating depth 61 cm
Altezza seduta / Seat height 48 cm

Altezza materasso / Mattress height
10 cm (materasso in poliuretano / polyurethane mattress)

Struttura Struttura in acciaio rivestita in poliuretano espanso e fibra. **Mec- canismo** Meccanismo del letto in acciaio, verniciatura a polveri epossidiche, meccanismo con apertura a libro mediante ribaltamento della spalliera, sup- porto per dormire in doghe larghe in faggio stratificato anti affossamento. **Imbottitura** Poliuretano espanso senza CFC a quote differenziate e ovatta poliestere. **Materasso** Materasso in poliuretano espanso H 11 cm a una densità 25 kg/m³. **Sfoderabilità** Poltrona completamente sfoderabile.

Structure Steel frame upholstered in polyurethane foam and fibre. **Bed mechanism** Steel bed mechanism with epoxy powder coating and book- style opening system with backrest tilt; laminated beech wide slats anti-sag sleeping base. **Padding** CFC-free polyurethane foam with differentiated densities, covered with polyester wadding. **Mattress** Polyurethane foam mattress, 11 cm thick (density 25 kg/m³). **Removable covers** Fully remov- able upholstery.

Poltrona letto /
Chair bed
75x185 cm

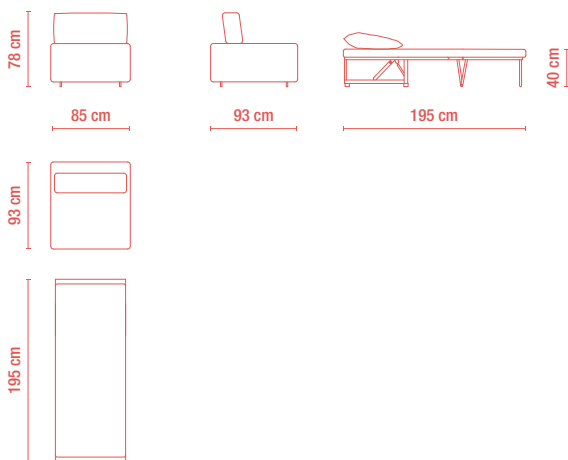

Profondità seduta / Seating depth 60 cm
Altezza seduta / Seat height 46 cm

Altezza materasso / Mattress height
11 cm (materasso in poliuretano / polyurethane mattress)

Struttura Inserto in legno rivestito in poliuretano espanso e fibra. **Meccanismo** Meccanismo del letto in acciaio, verniciatura a polveri epossidiche, meccanismo con pistoni ad aria, supporto per dormire in MDF. **Imbottitura** Poliuretano espanso senza CFC a quote differenziate e ovatta poliestere. **Sfoderabilità** Divano completamente sfoderabile.

Structure Wooden insert upholstered in polyurethane foam and fibre. **Bed mechanism** Steel bed mechanism with epoxy powder coating and air-piston assisted opening system; MDF sleeping base. **Padding** CFC-free polyurethane foam with differentiated densities, covered with polyester wadding. **Removable covers** Fully removable upholstery.

Divano letto singolo e letto matrimoniale con tre schienali / Single sofa bed and super king size sofa bed with three freestanding cushions
112x200 cm
193x185 cm

Divano letto singolo e contenitore portaoggetti con tre schienali / Single sofa bed with glove compartment with three freestanding cushions
112x200 cm

Altezza seduta / Seat height 41 cm

Altezza materasso / Mattress height 14 cm

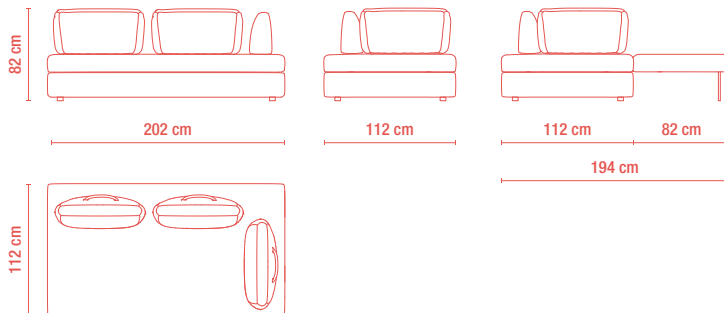

Bitta

DESIGNER DENIS SANTACHIARA

Struttura Poliuretano espanso a differenti densità, rivestito in fibra poliestere e lycra. **Materassino** Materassino gonfiabile in PVC con pompa integrata H 48 cm, tecnologia in fibertech, peso massimo supportato 120 kg. Tempo di gonfiaggio 3 min circa. **Sfoderabilità** Materasso completamente sfoderabile.

Structure Polyurethane foam with differentiated densities, upholstered in polyester fibre and Lycra. **Mattress pad** Inflatable PVC mattress pad with integrated pump, 48 cm high, FiberTech™ technology, maximum supported weight 120 kg, approx. 3-minute inflation time. **Removable covers** Mattress pad fully removable.

Pouf multifunzionale e letto singolo autogonfiabile / Multifunctional Stool and single airbed
95x200 cm

Altezza seduta / Seat height 54 cm

Altezza materasso / Mattress height 48 cm (materasso in PVC gonfiabile / inflatable PVC mattress)

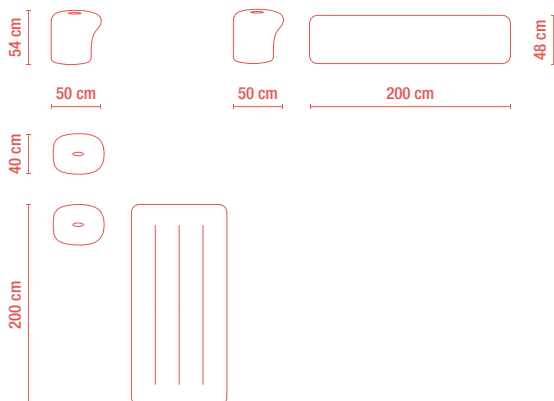

Brando

DESIGNER GIUSEPPE AREZZI

Struttura Legno in frassino verniciato trasparente, traversi superiori finali in acciaio cromato. **Cuscino** Inserto in acciaio rivestito in poliuretano rivestito in fibra poliestere. **Supporto** Molle d'acciaio cromato, telo 100% cotone. **Imbottitura** Fibra poliestere 200 g/m², rivestimento in cotone.

Structure Transparent painted ash wood, crossbars in chrome-plated steel. **Cushion** Steel insert covered with polyurethane density D25 covered with polyester fiber. **Support** Chrome-plated steel springs, canvas 100% cotton. **Padding** 200 g/m² polyester fiber, cotton cover.

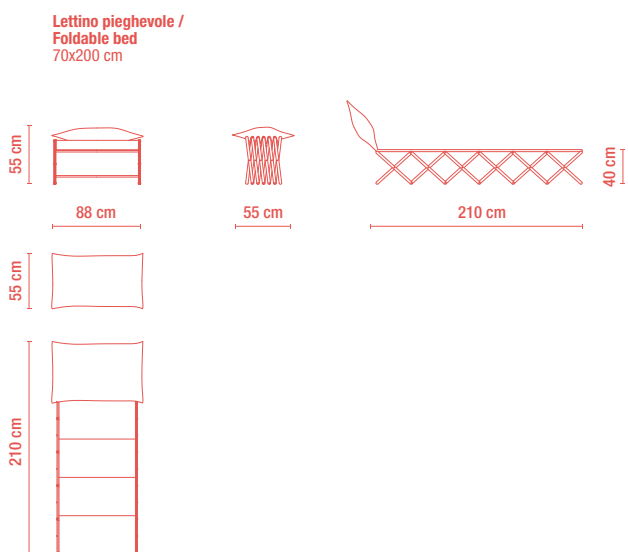

Altezza seduta / Seat height 55 cm

Broomstick Uno

DESIGNER VICO MAGISTRETTI

Struttura Legno in faggio naturale verniciato trasparente o blu. **Ferramenta** metallo verniciato nero.

Structure Natural beech wood painted transparent or blue. **Steel Structure** Painted black metal.

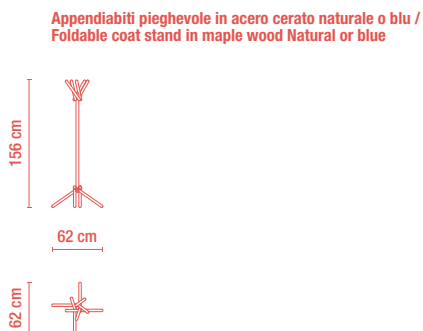

Struttura Struttura in acciaio rivestito in poliuretano espanso e fibra. **Mecanismo** Meccanismo del letto in acciaio, verniciatura a polveri epossidiche, meccanismo ad estrazione dotato di sistema di sollevamento semiautomatico mediante maniglia, supporto per dormire in doghe larghe in faggio stratificato anti affossamento. **Imbottitura** Poliuretano espanso senza CFC a quote differenziate e ovatta poliestere. **Materassi** Materasso in poliuretano espanso H 14 cm a una densità 25 kg/m³; Materasso a molle H 14 cm con rinforzo in poliuretano sul lato superiore. **Sfoderabilità** Divano completamente sfoderabile.

Structure Steel frame upholstered in polyurethane foam and fibre. **Bed mechanism** Steel bed mechanism with epoxy powder coating and pull-out system featuring a semi-automatic lifting mechanism operated by handle; laminated beech wide slats anti-sag sleeping base. **Padding** CFC-free polyurethane foam with differentiated densities, covered with polyester wadding. **Mattresses** Polyurethane foam mattress, 14 cm thick (density 25 kg/m³); Spring mattress, 14 cm thick, with polyurethane reinforcement on the top side. **Removable covers** Fully removable upholstery.

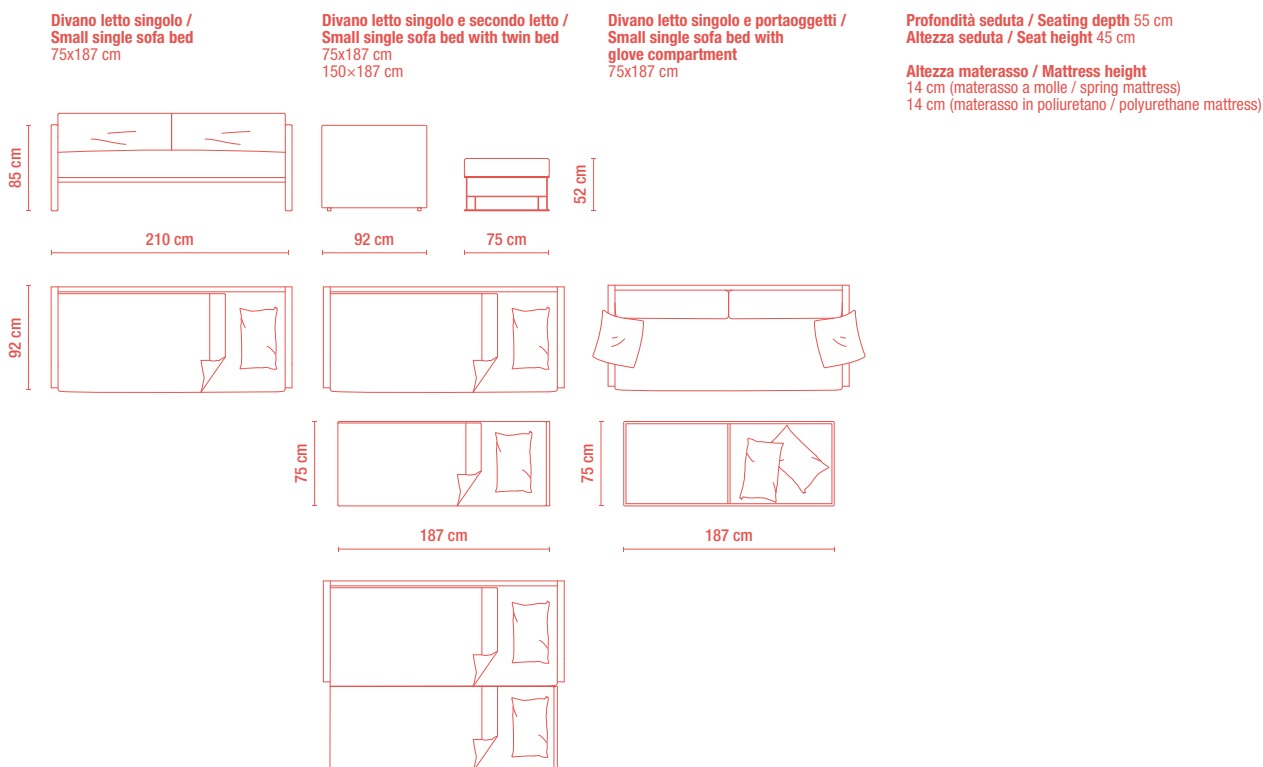

Canispè

Struttura Struttura portante in legno multistrato rivestito in poliuretano espanso. **Imbottitura** Poliuretano espanso rivestito in fibra poliestere 100 gr/m². **Piedino** Acciaio verniciato nero opaco. **Rivestimento base cuccia** Ecopelle.

Structure Load-bearing plywood frame upholstered in polyurethane foam. **Padding** Polyurethane foam upholstered in polyester fibre, 100 g/m². **Feet** Matt black painted steel. **Base cover** Eco-leather.

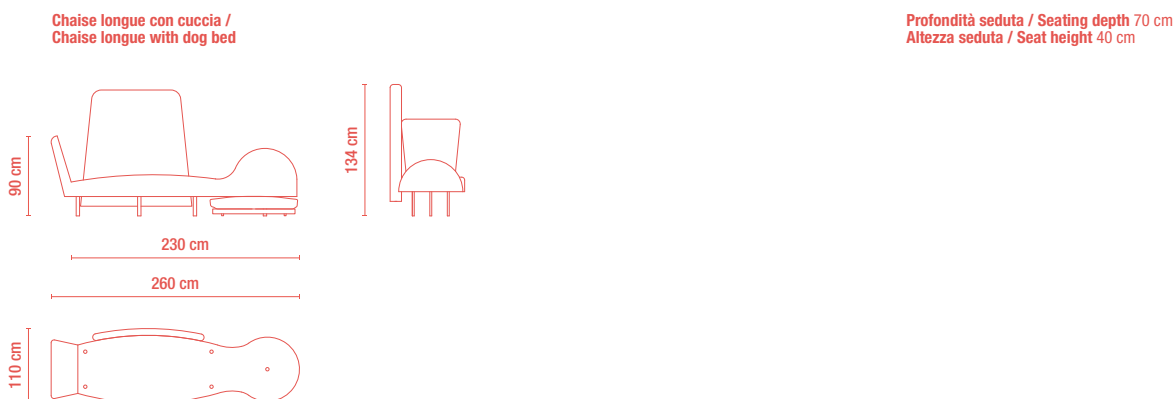

Struttura Inserto in legno e acciaio rivestito in poliuretano espanso e fibra. **Meccanismo** Meccanismo del letto in acciaio, verniciatura a polveri epossidiche, meccanismo con apertura sincronizzata mediante ribaltamento della spalliera, supporto per dormire in maglia d'acciaio elettrosaldata. **Bracciolo** Bracciolo in pelle naturale. **Imbottitura** Poliuretano espanso senza CFC a quote differenziate e ovatta poliestere. **Piedino** Piedino in fusione di alluminio brunito H 13 cm. **Materassi** Materasso in poliuretano espanso H 12 cm a una densità 25 kg/m³; Materasso a molle H 12 cm con rinforzo in poliuretano sul lato superiore. **Sfoderabilità** Divano completamente sfoderabile.

Structure Wooden and steel insert upholstered in polyurethane foam and fibre. **Bed mechanism** Steel bed mechanism with epoxy powder coating and synchronized opening system with backrest tilt; electro-welded steel mesh sleeping base. **Armrest** Natural leather armrest. **Padding** CFC-free polyurethane foam with differentiated densities, covered with polyester wadding. **Feet** Burnished cast aluminium feet, 13 cm high. **Mattresses** Polyurethane foam mattress, 12 cm thick (density 25 kg/m³); Spring mattress, 12 cm thick, with polyurethane reinforcement on the top side. **Removable covers** Fully removable upholstery.

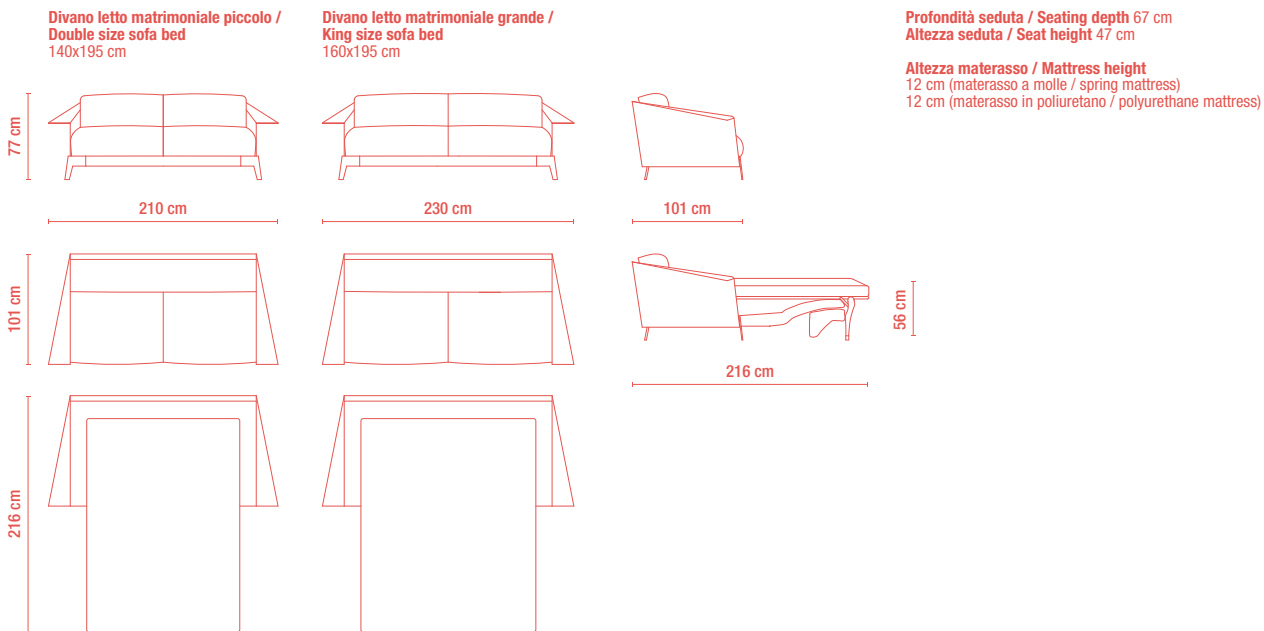

Struttura Inserto in legno rivestito in poliuretano espanso e fibra. **Imbottitura** Poliuretano espanso senza CFC a quote differenziate e ovatta poliestere. **Piedino** Piedino in legno di ciliegio H 10 cm. **Sfoderabilità** Divano completamente sfoderabile.

Structure Wooden insert upholstered in polyurethane foam and fibre. **Padding** CFC-free polyurethane foam with differentiated densities, covered with polyester wadding. **Feet** Cherry wood feet, 10 cm high. **Removable covers** Fully removable upholstery.

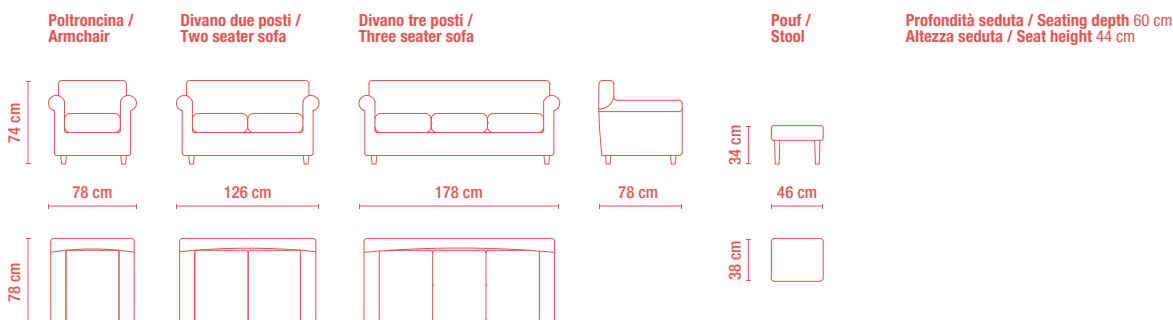

Commedia

DESIGNER JULIE RICHOUZ

Struttura Struttura in legno + struttura portante in ferro verniciato a liquido in colore azzurro o nero. **Imbottitura** Seduta parte superiore in poliuretano espanso ELAST densità 30 kg/m³ / parte inferiore densità 35 kg/m³. **Bracciolo** Bracciolo in poliuretano espanso densità 40 kg/m³. **Schienale** Barra a sezione circolare diametro 6 cm in faggio naturale verniciato trasparente, rimovibile. **Cuscini** Imbottitura in piuma con lama centrale in poliuretano densità 25 kg/m³. **Sfoderabilità** Divano completamente sfoderabile.

Structure Wooden frame with load-bearing steel structure, liquid-painted in light blue or black. **Padding** Seat padding with upper layer in ELAST polyurethane foam, density 30 kg/m³, and lower layer density 35 kg/m³. **Armrest** Armrest padding in polyurethane foam, density 40 kg/m³. **Backrest** Solid beech circular-section bar, Ø 6 cm, natural finish with clear lacquer, removable. **Cushions** Feather padding with central polyurethane foam core, density 25 kg/m³. **Removable covers** Fully removable upholstery.

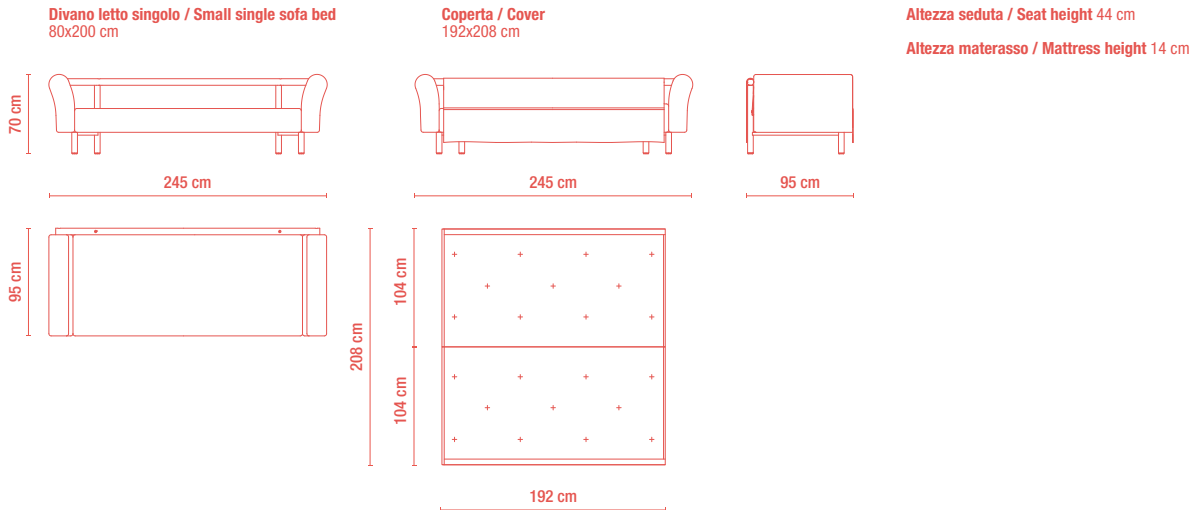

Cy

DESIGNER CAMPEGGI DESIGN

Struttura Inserto in legno rivestito in poliuretano espanso e fibra. **Meccanismo** Meccanismo del letto in acciaio, verniciatura a polveri epossidiche, meccanismo con apertura sincronizzata mediante ribaltamento della spalliera, supporto per dormire in doghe larghe in faggio stratificato anti affossamento. **Imbottitura** Poliuretano espanso senza CFC a quote differenziate e ovatta poliestere. **Materassi** Materasso in poliuretano espanso H 12 cm a una densità 25 kg/m³; Materasso a molle H 14 cm composto da Molleggio Bonnel 2.0 e lastra di espanso FE21 su entrambi i lati. **Sfoderabilità** Divano completamente sfoderabile.

Structure Wooden insert upholstered in polyurethane foam and fibre. **Bed mechanism** Steel bed mechanism with epoxy powder coating and synchronized opening system with backrest tilt; laminated beech wide slats anti-sag sleeping base. **Padding** CFC-free polyurethane foam with differentiated densities, covered with polyester wadding. **Mattresses** Polyurethane foam mattress, 12 cm thick (density 25 kg/m³); Spring mattress, 14 cm thick, with Bonnel 2.0 **spring** system and FE21 foam layer on both sides. **Removable covers** Fully removable upholstery.

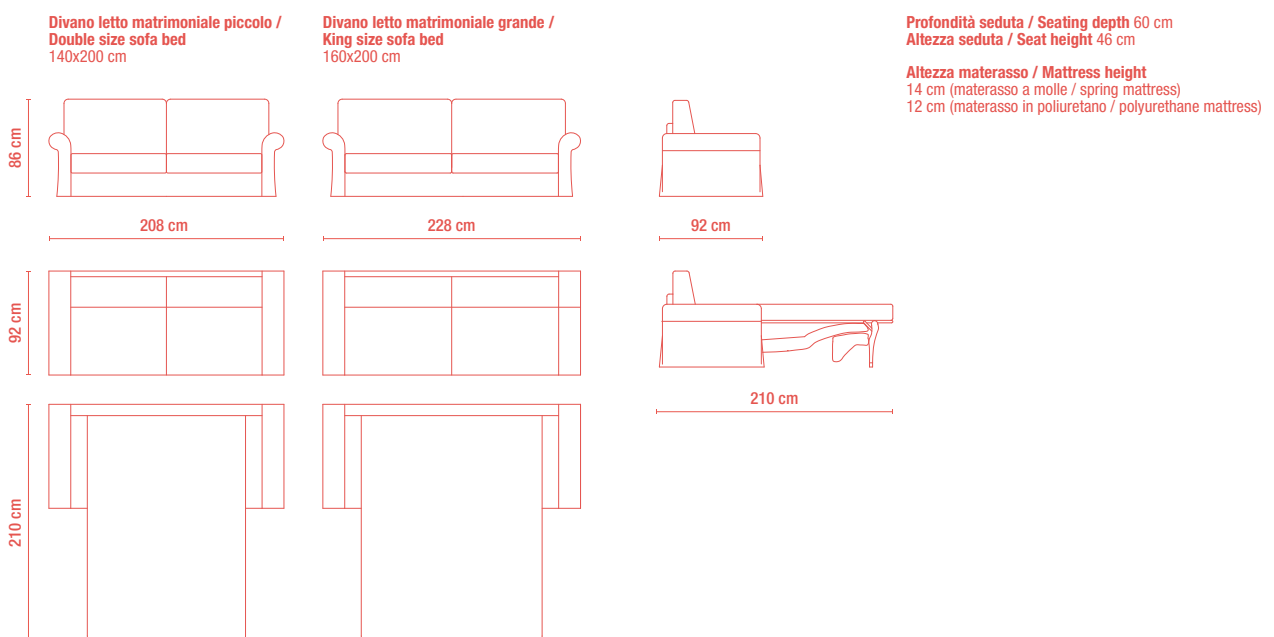

Struttura Struttura in acciaio. **Meccanismo** Meccanismo del letto in acciaio, verniciatura a polveri epossidiche, meccanismo con apertura ad alzata frontale per pronto letto, supporto per dormire in doghe larghe in faggio stratificato anti affossamento. **Imbottitura** Poliuretano espanso senza CFC a quote differenziate e ovatta poliestere. **Piedino** Piedino in legno di faggio H 13 cm. **Materasso** Materasso in poliuretano espanso H 12 cm a una densità 25 kg/m³. **Sfoderabilità** Divano completamente sfoderabile.

Structure Steel frame. **Bed mechanism** Steel bed mechanism with epoxy powder coating and front lifting opening system for ready-bed use; laminated beech wide slats anti-sag sleeping base. **Padding** CFC-free polyurethane foam with differentiated densities, covered with polyester wadding. **Feet** Beech wood feet, 13 cm high. **Mattress** Polyurethane foam mattress, 12 cm thick (density 25 kg/m³). **Removable covers** Fully removable upholstery.

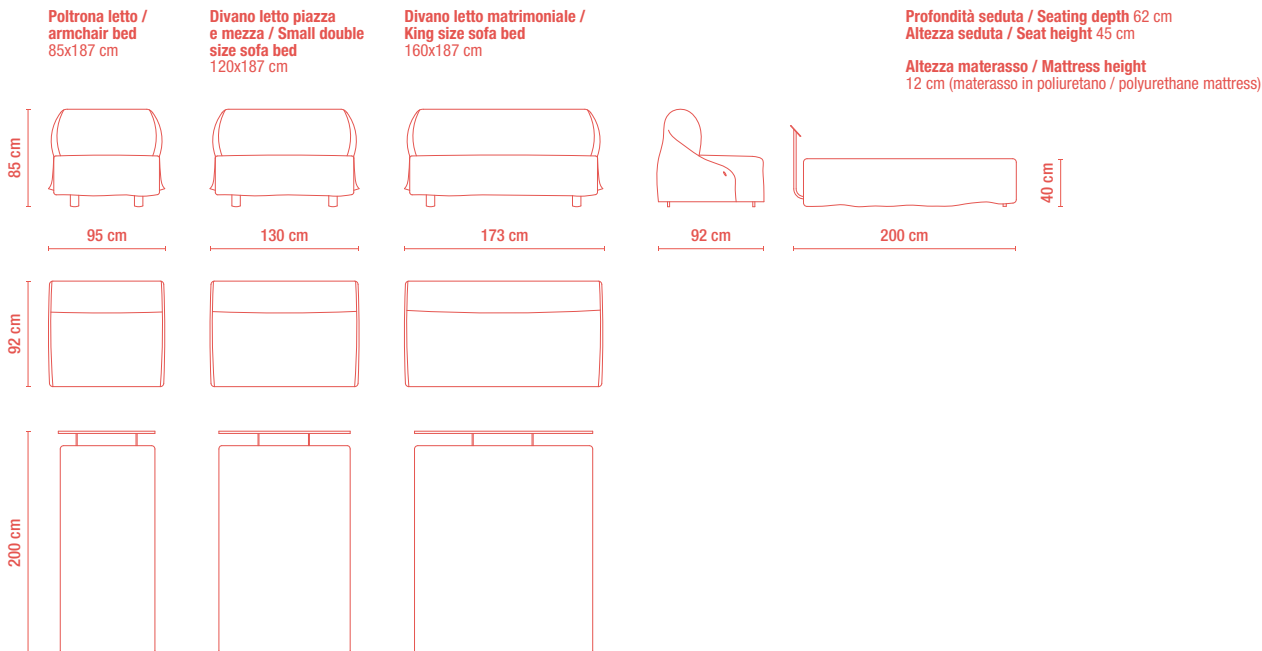

Struttura Struttura in acciaio. **Meccanismo** Meccanismo del letto in acciaio, verniciatura a polveri epossidiche, meccanismo con apertura ad alzata frontale per pronto letto, supporto per dormire in doghe larghe in faggio stratificato anti affossamento. **Imbottitura** Poliuretano espanso senza CFC a quote differenziate e ovatta poliestere. **Piedino** Piedino in legno di faggio H 13 cm. **Materasso** Materasso in poliuretano espanso H 12 cm a una densità 25 kg/m³. **Sfoderabilità** Divano completamente sfoderabile.

Structure Steel frame. **Bed mechanism** Steel bed mechanism with epoxy powder coating and front lifting opening system for ready-bed use; laminated beech wide slats anti-sag sleeping base. **Padding** CFC-free polyurethane foam with differentiated densities, covered with polyester wadding. **Feet** Beech wood feet, 13 cm high. **Mattress** Polyurethane foam mattress, 12 cm thick (density 25 kg/m³). **Removable covers** Fully removable upholstery.

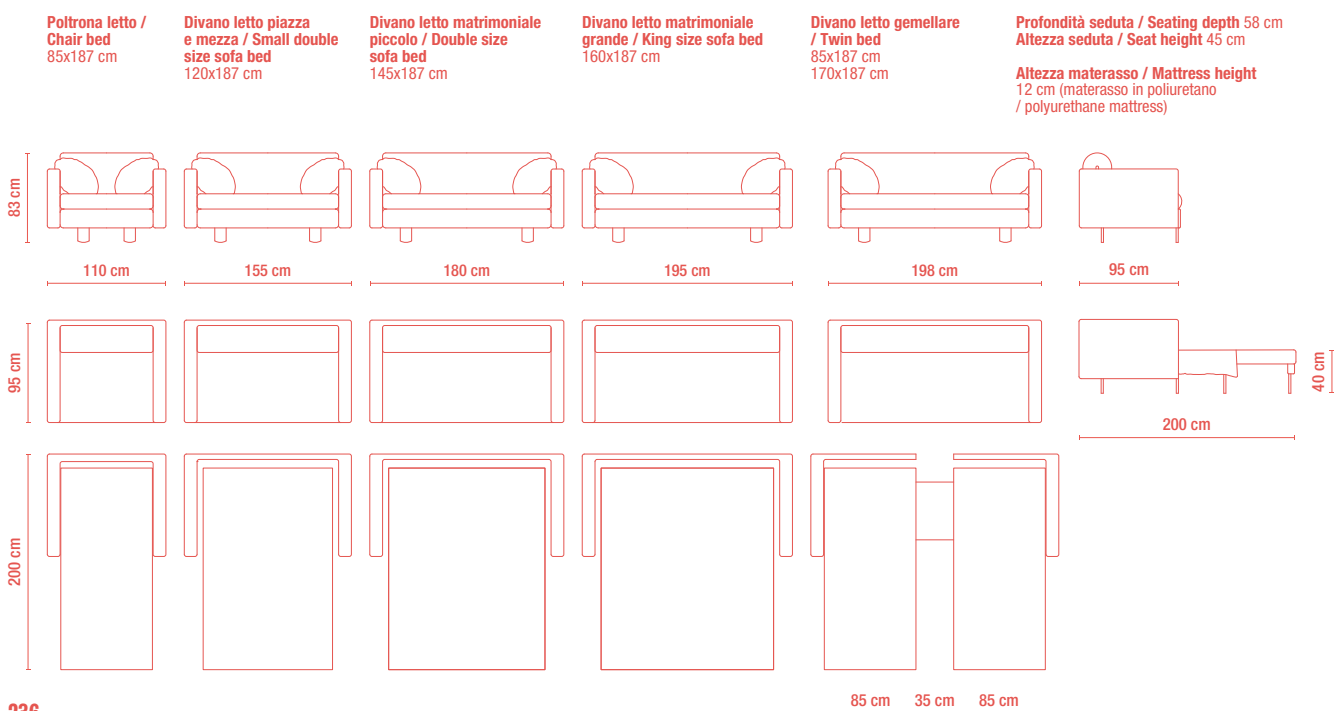

Struttura Inserto in legno rivestito in poliuretano espanso e fibra. **Meccanismo** Meccanismo del letto in acciaio, verniciatura a polveri epossidiche, meccanismo per divano letto trasversale con apertura sincronizzata mediante ribaltamento della spalliera, supporto per dormire in maglia d'acciaio elettrosaldata. **Imbottitura** Poliuretano espanso senza CFC a quote differenziate e ovatta poliestere. **Materasso** H 12 cm in poliuretano espanso a una densità 25 Kg/m³. **Sfoderabilità** Divano completamente sfoderabile.

Structure Wooden insert upholstered in polyurethane foam and fibre. **Bed mechanism** Steel bed mechanism with epoxy powder coating for transverse sofa-bed, featuring a synchronized opening system with backrest tilt; electro-welded steel mesh sleeping base. **Padding** CFC-free polyurethane foam with differentiated densities, covered with polyester wadding. **Mattress** Polyurethane foam mattress, 12 cm thick (density 25 kg/m³). **Removable covers** Fully removable upholstery.

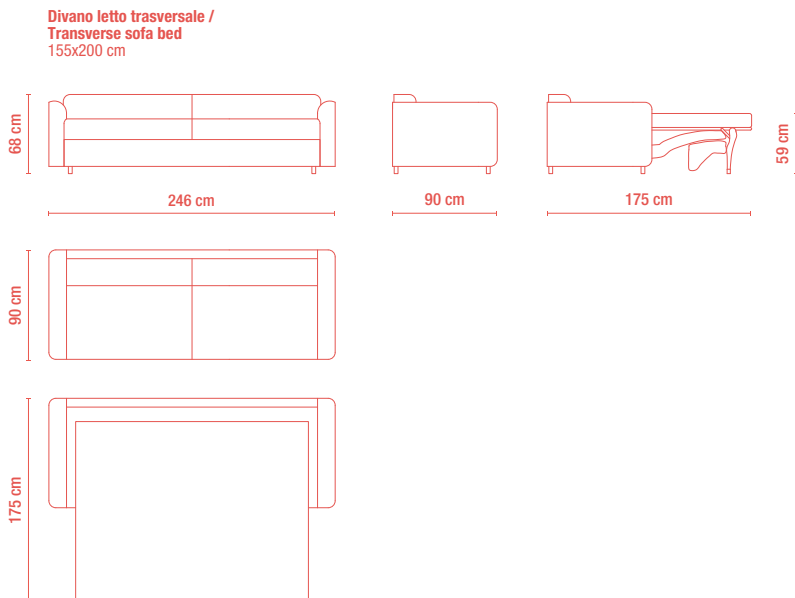

Profondità seduta / Seating depth 63 cm
Altezza seduta / Seat height 47 cm

Altezza materasso / Mattress height
12 cm (materasso in poliuretano / polyurethane mattress)

Dudù

Struttura Struttura in acciaio. **Meccanismo** Meccanismo del letto in acciaio, verniciatura a polveri epossidiche, meccanismo con apertura a pettine, supporto per dormire in doghe di faggio stratificato anti affossamento. **Imbottitura** Poliuretano espanso senza CFC a quote differenziate e ovatta poliestere. **Piedino** Piedino in acciaio H 16 cm. **Schienale** Barra a sezione circolare diametro 4 cm in faggio naturale verniciato trasparente, rimovibile. **Materassi** Letto singolo Materasso H 20 cm in poliuretano espanso a una densità 25 Kg/m³; Letto doppio Materasso H 10 cm in poliuretano espanso a una densità 25 Kg/m³. **Sfoderabilità** Divano completamente sfoderabile.

Structure Steel frame. **Bed mechanism** Steel bed mechanism with epoxy powder coating and comb-style opening system; laminated beech slats anti-sag sleeping base. **Padding** CFC-free polyurethane foam with differentiated densities, covered with polyester wadding. **Feet** Steel feet, 16 cm high. **Backrest** Solid beech circular-section bar, Ø 4 cm, natural finish with clear lacquer, removable. **Mattresses** Single bed Polyurethane foam mattress, 20 cm thick (density 25 kg/m³); Double bed Polyurethane foam mattress, 10 cm thick (density 25 kg/m³). **Removable covers** Fully removable upholstery.

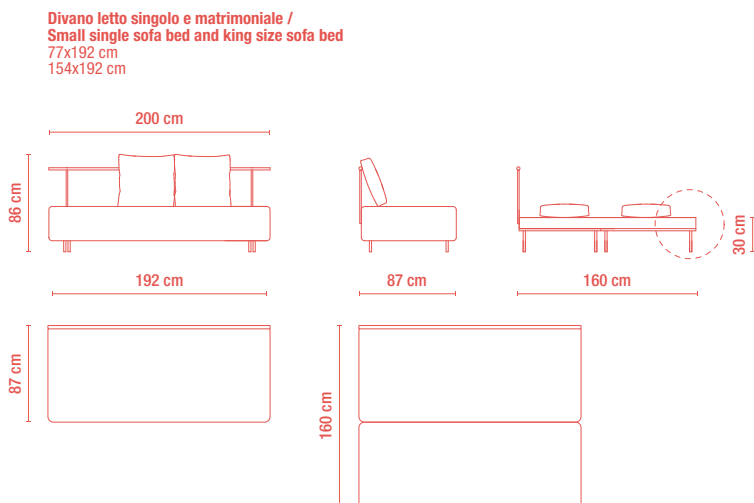

Altezza seduta / Seat height 41 cm

Altezza materasso / Mattress height
Letto singolo / Single bed 20 cm
(materasso in poliuretano / polyurethane mattress)
Letto matrimoniale / King size bed 10 cm
(materasso in poliuretano / polyurethane mattress)

Fuoriuscita materasso / Mattress overhang
14 cm rispetto alla struttura /
14 cm beyond the frame

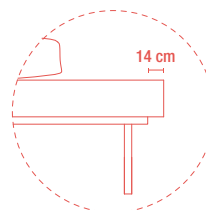

Struttura Inserto in legno rivestito in poliuretano espanso e fibra. **Imbottitura** Poliuretano espanso senza CFC a quote differenziate e ovatta poliestere. **Piedino** Piedino in faggio verniciato nero H 20 cm. **Sfoderabilità** Divano completamente sfoderabile.

Structure Wooden insert upholstered in polyurethane foam and fibre. **Padding** CFC-free polyurethane foam with differentiated densities, covered with polyester wadding. **Feet** Black-painted beech wood feet, 20 cm high. **Removable covers** Fully removable upholstery.

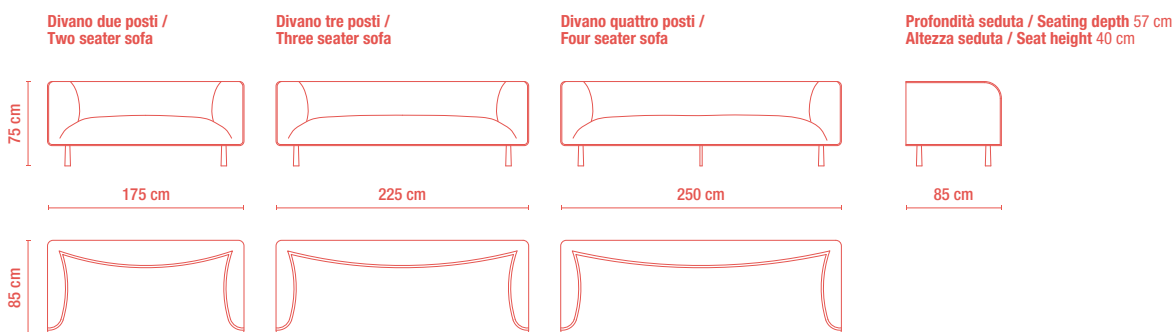

Fefè

DESIGNER CAMPEGGI DESIGN

Struttura Inserto in legno rivestito in poliuretano espanso e fibra. **Meccanismo** Meccanismo del letto in acciaio, verniciatura a polveri epossidiche, meccanismo ad estrazione dotato di sistema di sollevamento semiautomatico mediante maniglia, supporto per dormire in doghe larghe in faggio stratificato anti affossamento. **Imbottitura** Poliuretano espanso senza CFC a quote differenziate e ovatta poliestere. **Materasso** H 13 cm in poliuretano espanso a una densità 25 Kg/m³. **Sfoderabilità** Divano completamente sfoderabile.

Structure Wooden insert upholstered in polyurethane foam and fibre. **Bed mechanism** Steel bed mechanism with epoxy powder coating and pull-out system featuring a semi-automatic lifting mechanism operated by handle; laminated beech wide slats anti-sag sleeping base. **Padding** CFC-free polyurethane foam with differentiated densities, covered with polyester wadding. **Mattress** Polyurethane foam mattress, 13 cm thick (density 25 kg/m³). **Removable covers** Fully removable upholstery.

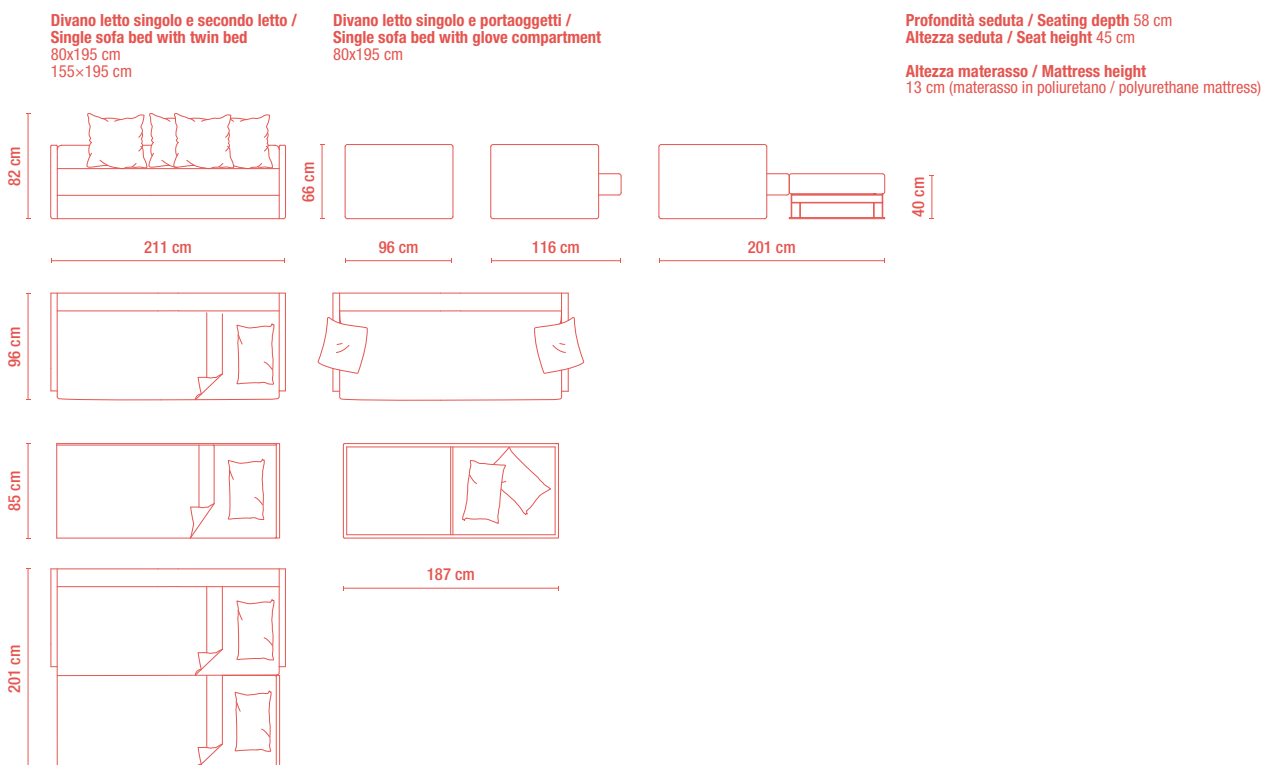

Struttura Inserto in legno rivestito in poliuretano espanso e fibra. **Meccanismo** Meccanismo del letto in acciaio, verniciatura a polveri epossidiche, meccanismo con sistema di apertura a sollevamento frontale a due tempi, supporto per dormire in maglia d'acciaio elettrosaldata. **Imbottitura** Poliuretano espanso senza CFC a quote differenziate e ovatta poliestere con inserti in piuma. **Materasso** Materasso a molle H 12 cm composto da Molleggio Bonnel 2.0, feltro morbido 1200gr/m³ su entrambi i lati, lastra di espanso FE21 su un lato. **Sfoderabilità** Divano completamente sfoderabile.

Structure Wooden insert upholstered in polyurethane foam and fibre. **Bed mechanism** Steel bed mechanism with epoxy powder coating and two-stage front lifting opening system; electro-welded steel mesh sleeping base. **Padding** CFC-free polyurethane foam with differentiated densities, covered with polyester wadding with down inserts. **Mattress** Spring mattress, 12 cm thick, with Bonnel 2.0 spring system, soft felt 1200 g/m³ on both sides, and FE21 foam layer on one side. **Removable covers** Fully removable upholstery.

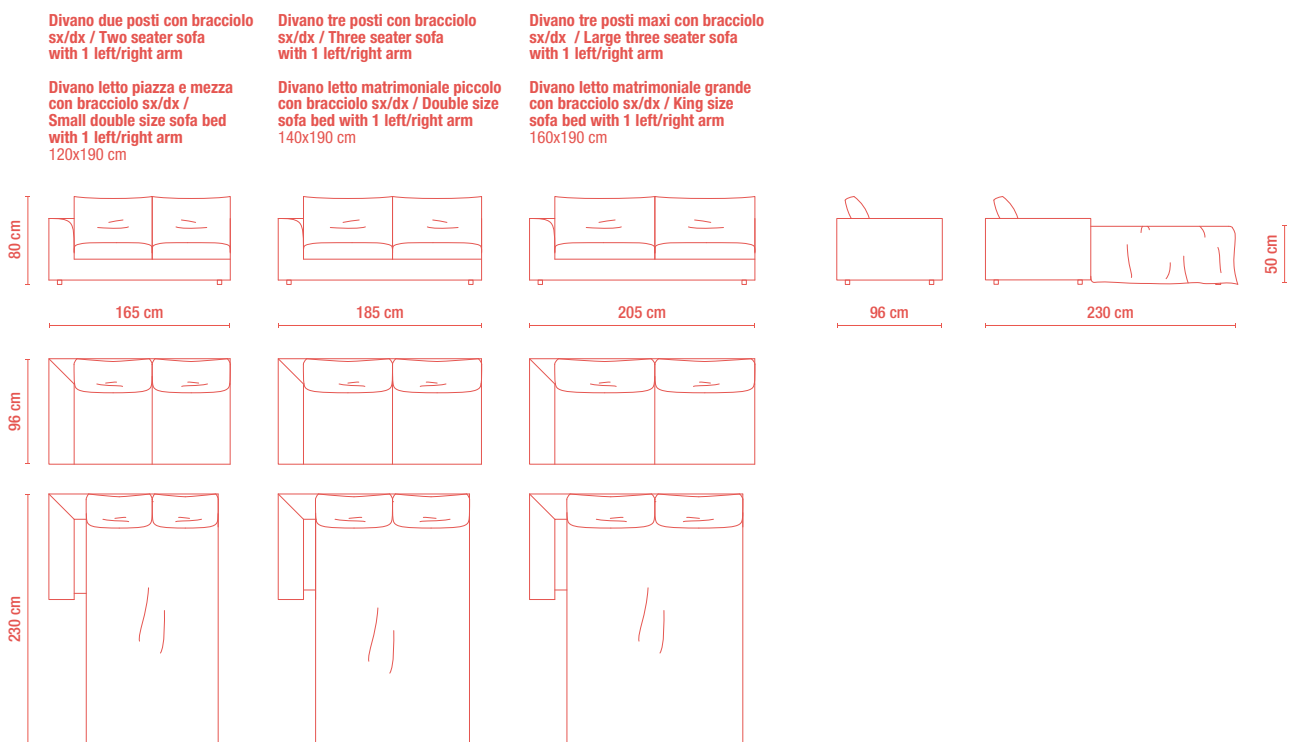
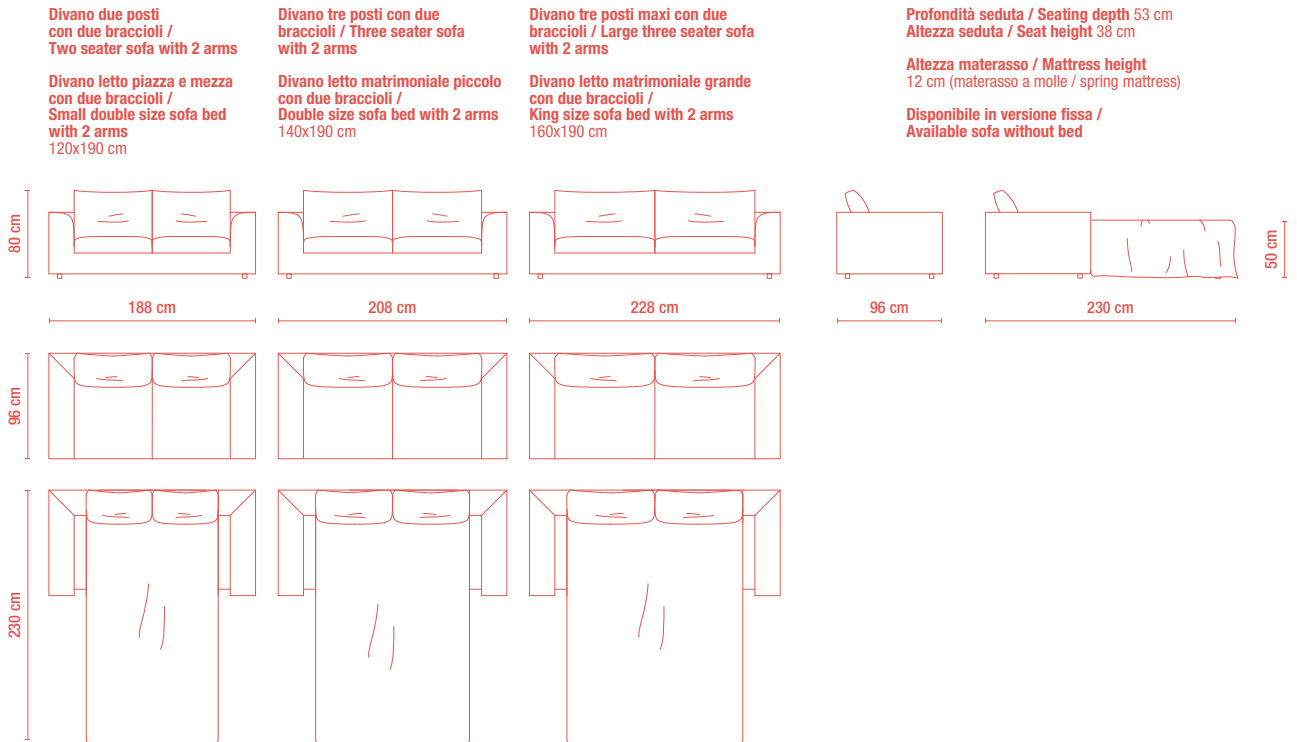

Divano due posti senza braccioli / Two seater sofa without arms

Divano letto piazza e mezza senza braccioli / Small double size sofa bed without arms
120x190 cm

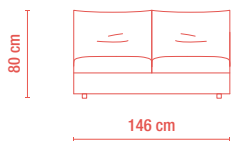

Divano tre posti senza braccioli / Three seater sofa without arms

Divano letto matrimoniale piccolo senza braccioli / Double size sofa bed without arms
140x190 cm

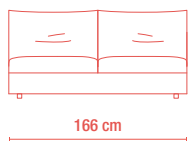

Divano tre posti maxi senza braccioli / Large three seater sofa without arms

Divano letto matrimoniale grande senza braccioli / King size sofa bed without arms
160x190 cm

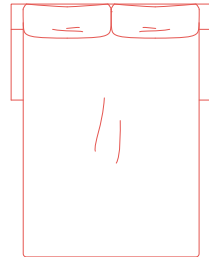
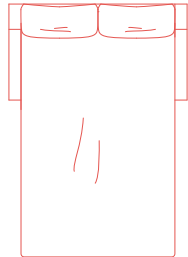
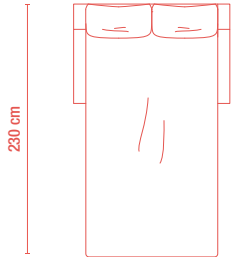
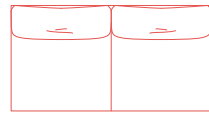
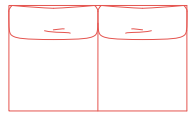
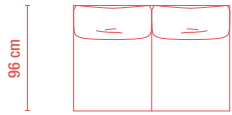
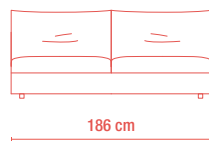

Poltrona lunga con due braccioli / Chaise longue with 2 arms

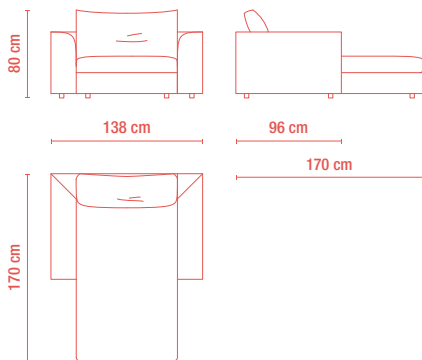

Poltrona lunga con bracciolo sx/dx / Chaise longue with 1 left/right arm

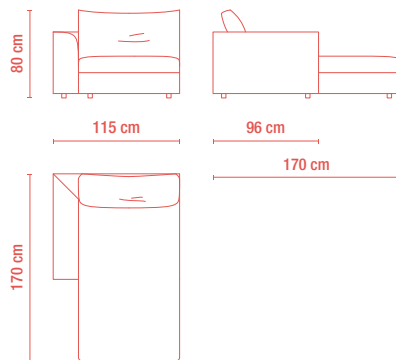

Poltrona lunga senza braccioli / Chaise longue without arms

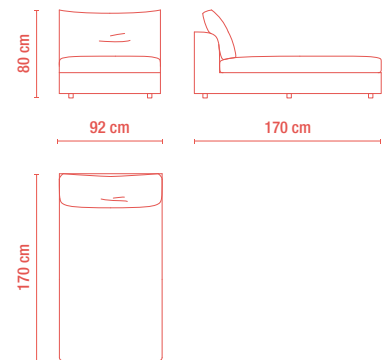

Poltrona terminale con bracciolo lungo sx/dx / Terminal chaise longue with 1 long left/right arm

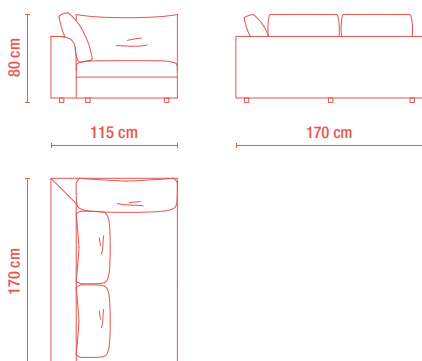

Sedile / Ottoman

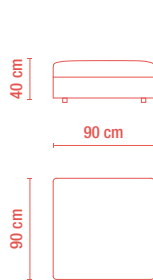

Struttura Struttura in poliuretano espanso rivestita in fibra poliestere e ecopelle. **Imbottitura** Poliuretano espanso senza CFC a quote differenziate e ovatta poliestere.

Structure Polyurethane foam structure upholstered in polyester fibre and eco-leather. **Padding** CFC-free polyurethane foam with differentiated densities, covered with polyester wadding.

Pouf composto da due sedute dondolanti /
Pouf with two rocking chairs

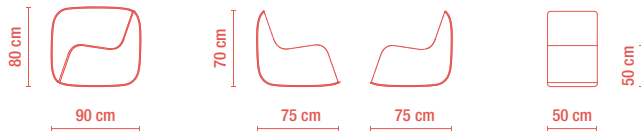

Profondità seduta / Seating depth 45 cm
Altezza seduta / Seat height 50 cm

Giù

DESIGNER CAMPEGGI DESIGN

Struttura Inserto in legno rivestito in poliuretano espanso e fibra. **Meccanismo** Meccanismo del letto in acciaio, verniciatura a polveri epossidiche, meccanismo con sistema di apertura a sollevamento frontale a due tempi, supporto per dormire in maglia d'acciaio elettrosaldata. **Imbottitura** Poliuretano espanso senza CFC a quote differenziate e ovatta poliestere. **Piedino** Piedino in alluminio satinato, brunito o verniciato nero, H 13 cm. **Materasso** Materasso a molle H 12 cm composto da Molleggio Bonnel 2.0, feltro morbido 1200gr/m³ su entrambi i lati, lastra di espanso FE21 su un lato. **Sfoderabilità** Divano completamente sfoderabile.

Structure Wooden insert upholstered in polyurethane foam and fibre. **Bed mechanism** Steel bed mechanism with epoxy powder coating and two-stage front lifting opening system; electro-welded steel mesh sleeping base. **Padding** CFC-free polyurethane foam with differentiated densities, covered with polyester wadding. **Feet** Aluminium feet, 13 cm high, satin-finished, burnished or painted black. **Mattress** Spring mattress, 12 cm thick, with Bonnel 2.0 spring system, soft felt 1200 g/m³ on both sides, and FE21 foam layer on one side, with quilted padding. **Removable covers** Fully removable upholstery.

Poltrona maxi /
Armchair maxi

Divano due posti /
Two seater sofa

Divano tre posti /
Three seater sofa

Divano tre posti maxi /
Large three seater sofa

Profondità seduta / Seating depth 55 cm
Altezza seduta / Seat height 43 cm

Poltrona letto /
Chair bed
80x195 cm

Divano letto piazza e mezza /
Small double size sofa bed
120x195 cm

Divano letto matrimoniale
piccolo / Double size sofa bed
140x195 cm

Divano letto matrimoniale grande /
King size sofa bed
160x195 cm

Altezza materasso / Mattress height
12 cm (materasso a molle / spring mattress)

Disponibile in versione fissa /
Available sofa without bed

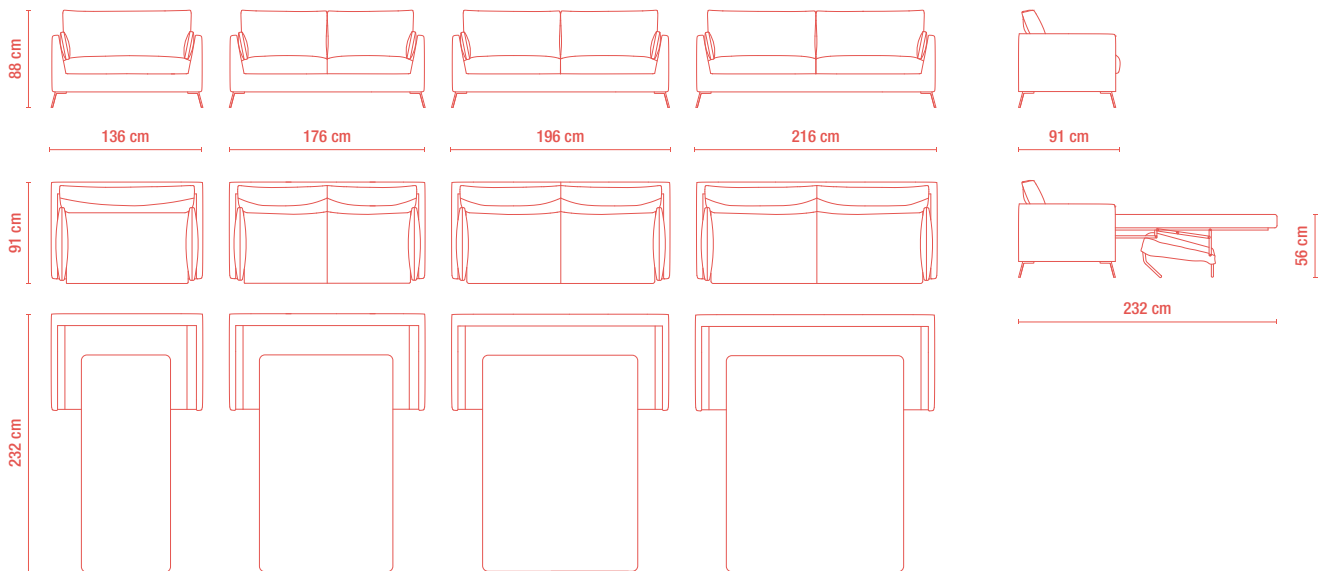

Divano tre posti mega /
Three seater sofa mega

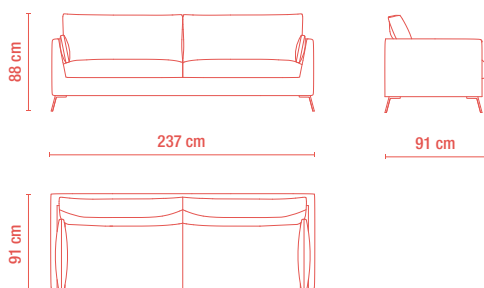

Struttura Inserto in legno rivestito in poliuretano espanso e fibra. **Meccanismo** Meccanismo del letto in acciaio, verniciatura a polveri epossidiche, meccanismo con apertura sincronizzata mediante ribaltamento della spalliera, supporto per dormire in maglia d'acciaio elettrosaldata. **Imbottitura** Poliuretano espanso senza CFC a quote differenziate e ovatta poliester. **Piedino** Piedino in resina colorato nero. **Materassi** Materasso in poliuretano espanso H 12 cm a una densità 25 kg/m³; Materasso a molle H 14 cm composto da Molleggio Bonnel 2.0 e lastra di espanso FE21 su entrambi i lati. **Sfoderabilità** Divano completamente sfoderabile.

Structure Wooden insert upholstered in polyurethane foam and fibre. **Bed mechanism** Steel bed mechanism with epoxy powder coating and synchronized opening system with backrest tilt; electro-welded steel mesh sleeping base. **Padding** CFC-free polyurethane foam with differentiated densities, covered with polyester wadding. **Feet** Black resin feet. **Mattresses** Polyurethane foam mattress, 12 cm thick (density 25 kg/m³); Spring mattress, 14 cm thick, with Bonnell 2.0 **spring** system and FE21 foam layer on both sides. **Removable covers** Fully removable upholstery.

GO – LARGHEZZA BRACCIOLO / ARMREST WIDTH 18 cm

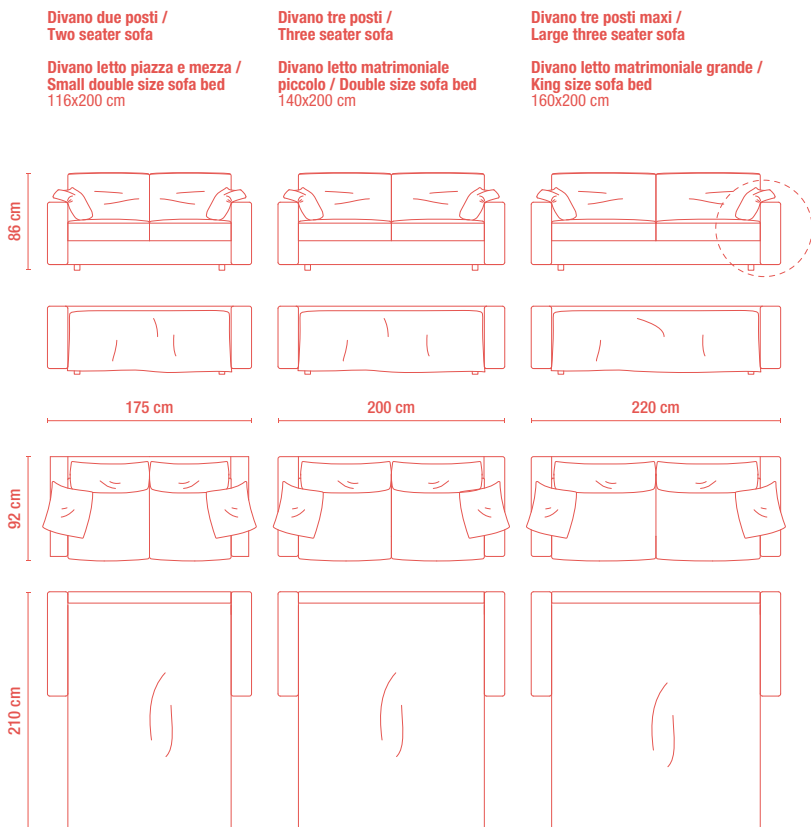

Profondità seduta / Seating depth 58 cm
Altezza seduta / Seat height 47 cm
Altezza materasso / Mattress height
 14 cm (materasso a molle / spring mattress)
 12 cm (materasso in poliuretano / polyurethane mattress)

Disponibile in versione fissa / Available sofa without bed

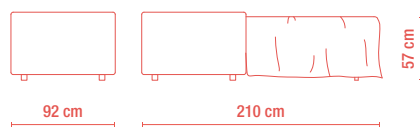

Sedile / Ottoman

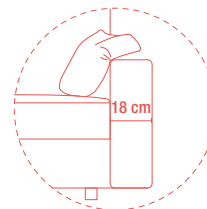
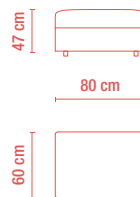

GO SMALL – LARGHEZZA BRACCIOLO / ARMREST WIDTH 8 cm

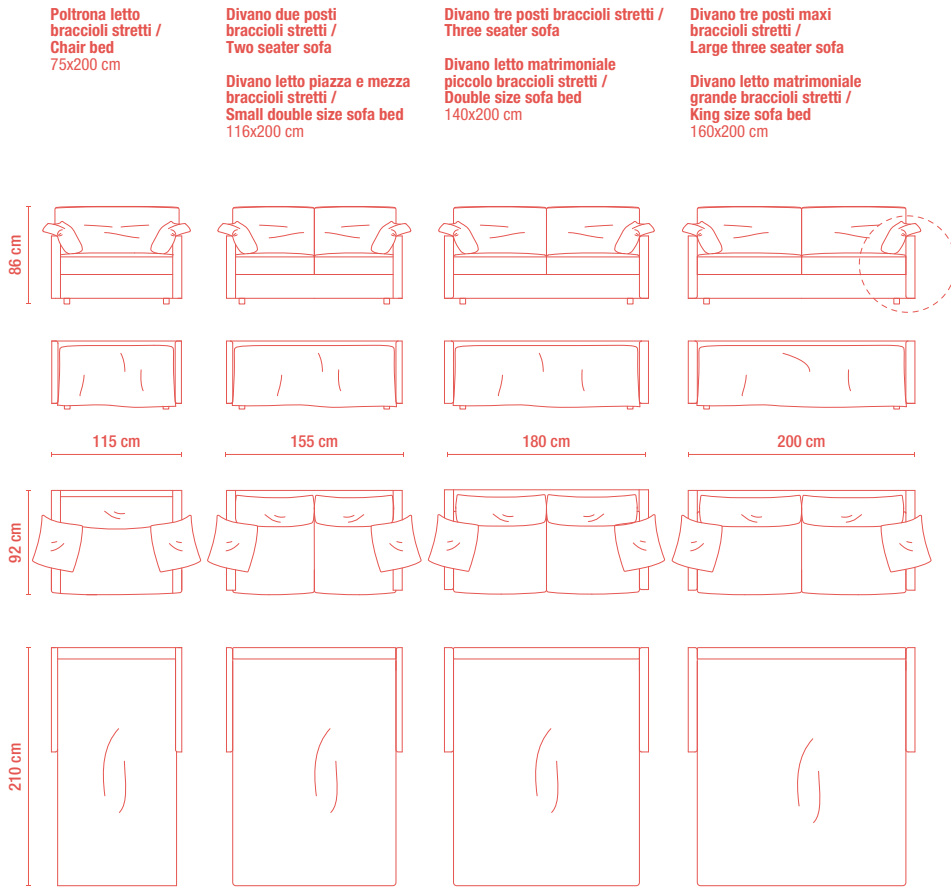

Profondità seduta / Seating depth 58 cm
Altezza seduta / Seat height 47 cm

Altezza materasso / Mattress height
14 cm (materasso a molle / spring mattress)
12 cm (materasso in poliuretano / polyurethane mattress)

Disponibile in versione fissa / Available sofa without bed

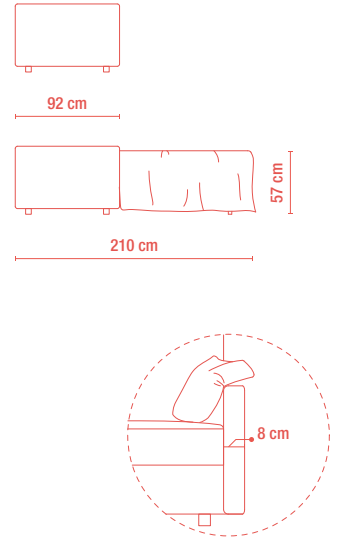

GO SLIM – LARGHEZZA BRACCIOLO / ARMREST WIDTH 4 cm

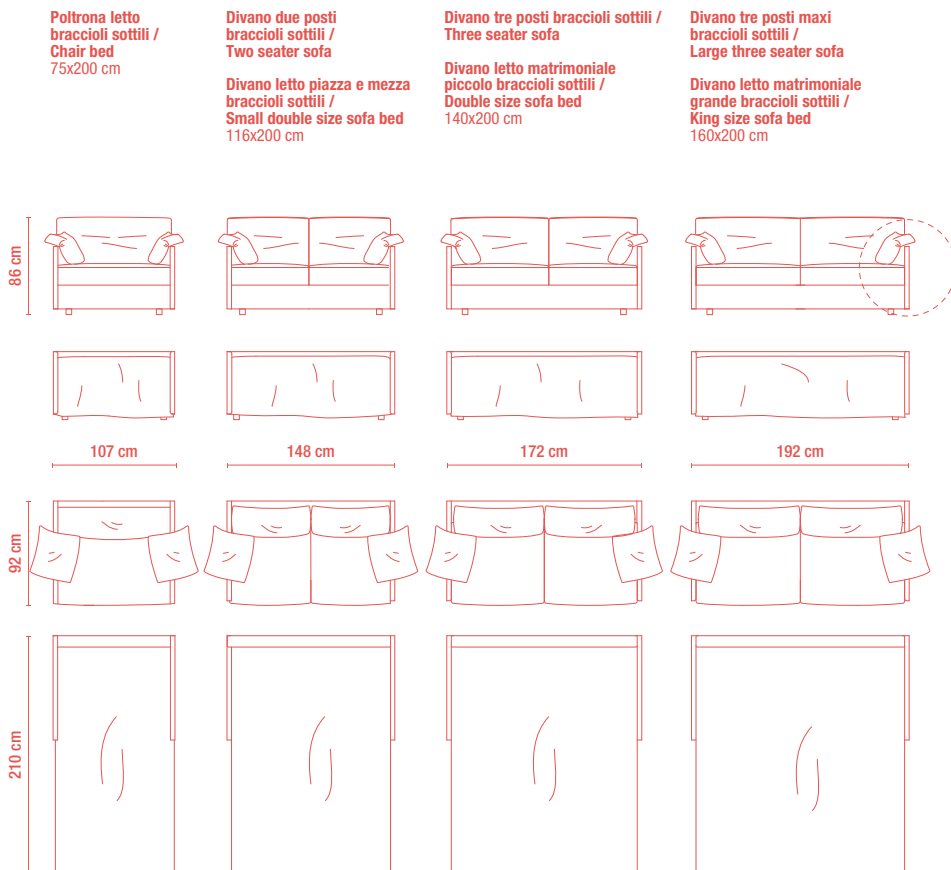

Profondità seduta / Seating depth 58 cm
Altezza seduta / Seat height 47 cm

Altezza materasso / Mattress height
14 cm (materasso a molle / spring mattress)
12 cm (materasso in poliuretano / polyurethane mattress)

Disponibile in versione fissa / Available sofa without bed

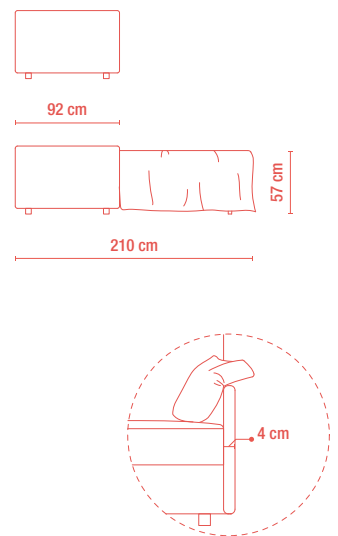

Struttura Inserto in legno rivestito in poliuretano espanso e fibra. **Meccanismo** Meccanismo del letto in acciaio, verniciatura a polveri epossidiche, meccanismo con apertura sincronizzata mediante ribaltamento della spalliera, supporto per dormire in doghe larghe in faggio stratificato anti affossamento. **Imbottitura** Poliuretano espanso senza CFC a quote differenziate e ovatta poliestere. **Piedino** Piedino in resina colorato nero. **Materassi** Materasso in poliuretano espanso H 19 cm a una densità 25 kg/m³; Materasso a molle H 19 cm composto da Molleggio Bonnel 2.0 e lastra di espanso FE21 su entrambi i lati; Materasso in memory foam (o schiuma in lattice) H 19 cm. **Sfoderabilità** Divano completamente sfoderabile.

Structure Wooden insert upholstered in polyurethane foam and fibre. **Bed mechanism** Steel bed mechanism with epoxy powder coating and synchronized opening system with backrest tilt; laminated beech wide slats anti-sag sleeping base. **Padding** CFC-free polyurethane foam with differentiated densities, covered with polyester wadding. **Feet** Black resin feet. **Mattresses** Polyurethane foam mattress, 19 cm thick (density 25 kg/m³); Spring mattress, 19 cm thick, with Bonnel 2.0 spring system and FE21 foam layer on both sides; Memory foam (or latex foam) mattress, 19 cm thick. **Removable covers** Fully removable upholstery.

GO.UP – LARGHEZZA BRACCIOLO / ARMREST WIDTH 18 cm

Divano due posti /
Two seater sofa

Divano letto piazza e mezza /
Small double size sofa bed
115x200 cm

Divano tre posti /
Three seater sofa

Divano letto matrimoniale
piccolo / Double size sofa bed
140x200 cm

Divano tre posti maxi /
Large three seater sofa

Divano letto matrimoniale grande /
King size sofa bed
160x200 cm

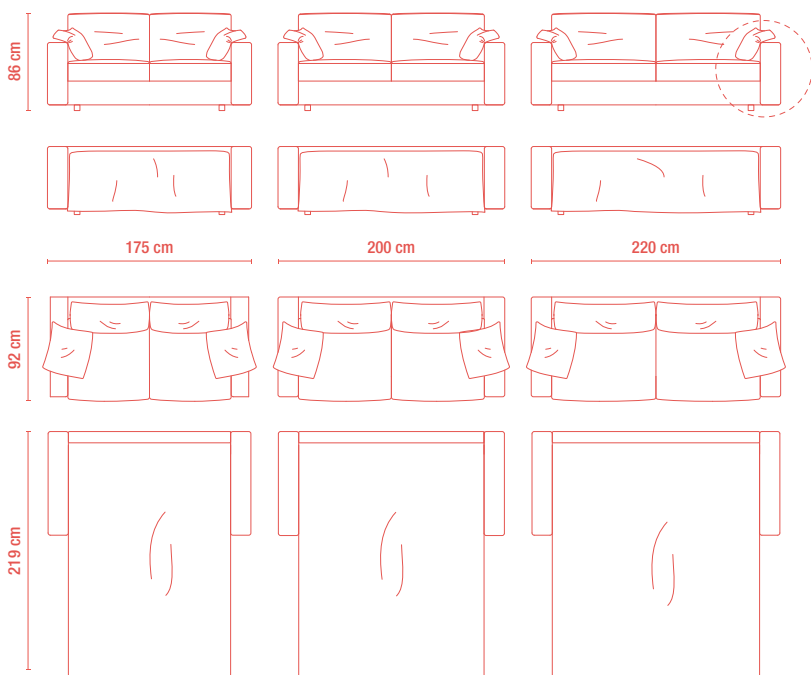

Profondità seduta / Seating depth 58 cm

Altezza seduta / Seat height 49 cm

Altezza materasso / Mattress height

19 cm (materasso a molle / spring mattress)

19 cm (materasso in poliuretano / polyurethane mattress)

19 cm (materasso in memory foam / memory foam mattress)

Disponibile in versione fissa / Available sofa without bed

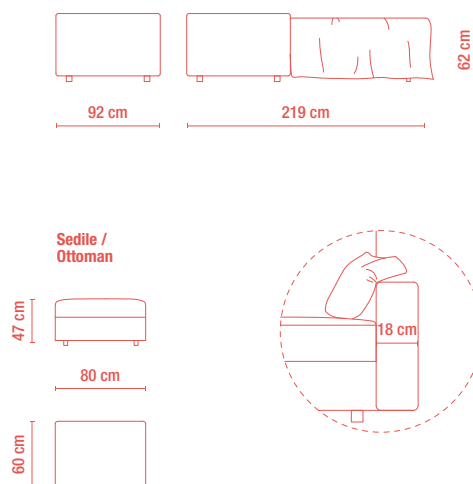

GO.UP SMALL – LARGHEZZA BRACCIOLO / ARMREST WIDTH 8 cm

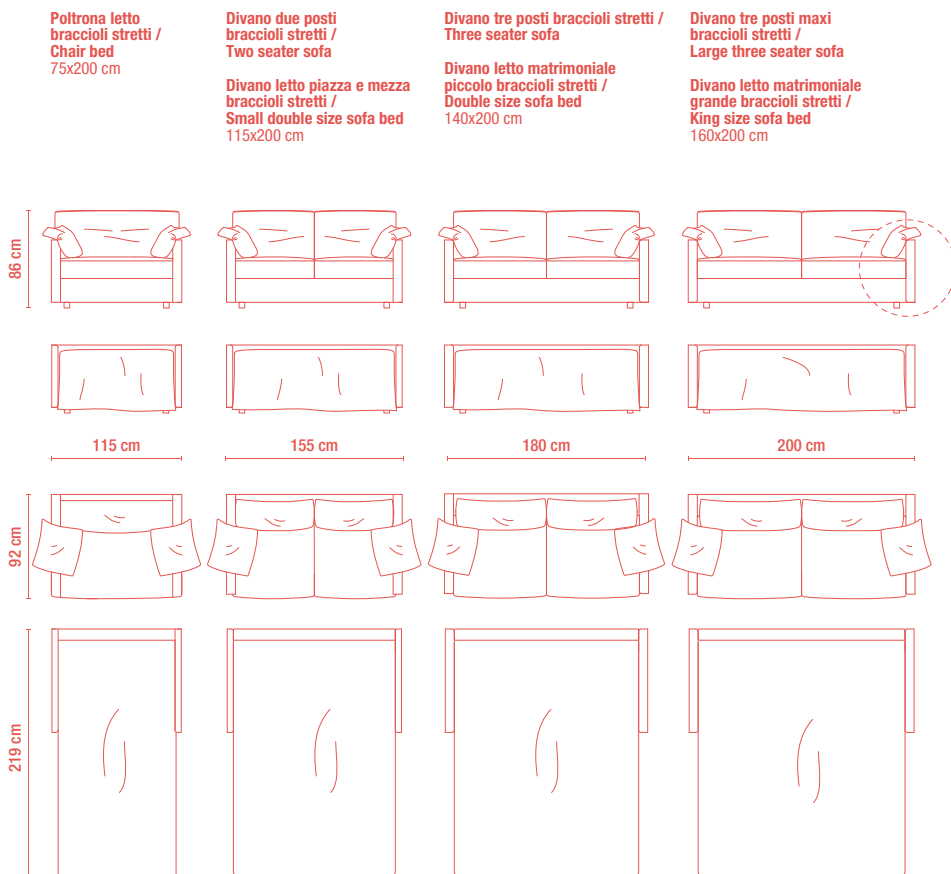

Profondità seduta / Seating depth 58 cm
Altezza seduta / Seat height 49 cm

Altezza materasso / Mattress height
19 cm (materasso a molle / spring mattress)
19 cm (materasso in poliuretano /
polyurethane mattress)
19 cm (materasso in memory foam /
memory foam mattress)

Disponibile in versione fissa /
Available sofa without bed

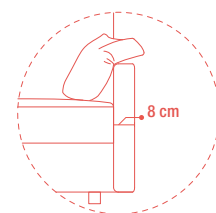
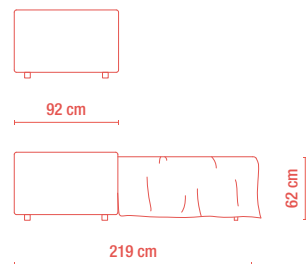

GO.UP SLIM – LARGHEZZA BRACCIOLO / ARMREST WIDTH 4 cm

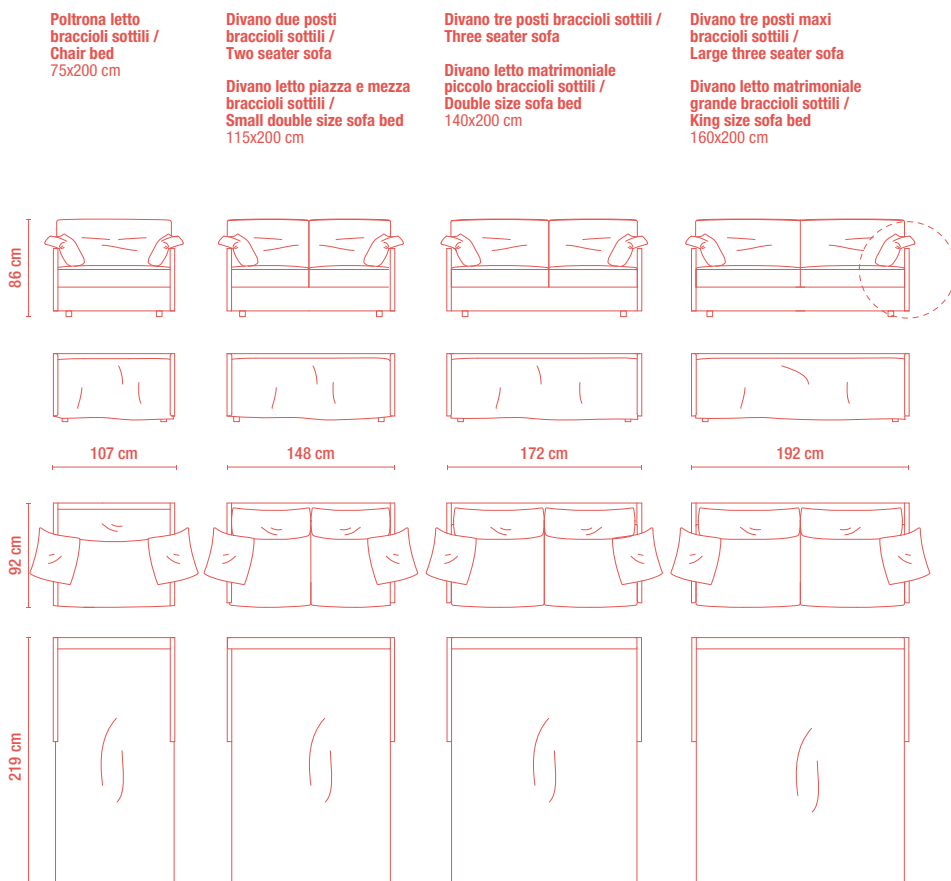

Profondità seduta / Seating depth 58 cm
Altezza seduta / Seat height 49 cm

Altezza materasso / Mattress height
19 cm (materasso a molle / spring mattress)
19 cm (materasso in poliuretano /
polyurethane mattress)
19 cm (materasso in memory foam /
memory foam mattress)

Disponibile in versione fissa /
Available sofa without bed

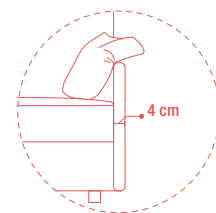
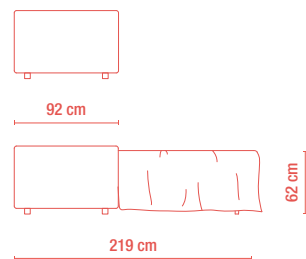

Struttura Inserto in acciaio verniciato con cinghie elastiche, rivestimento in poliuretano espanso e fibra. **Meccanismo** Meccanismo del letto in acciaio, verniciatura a polveri epossidiche, meccanismo con apertura sincronizzata mediante ribaltamento della spalliera, supporto per dormire in maglia d'acciaio elettrosaldata. **Imbottitura** Poliuretano espanso senza CFC a quote differenziate e ovatta poliestere. **Materasso** H 12 cm in poliuretano espanso a una densità 25 Kg/m³. **Sfoderabilità** Divano completamente sfoderabile.

Structure Steel frame with elastic webbing, upholstered in polyurethane foam and fibre. **Bed mechanism** Steel bed mechanism with epoxy powder coating and synchronized opening system with backrest tilt; electro-welded steel mesh sleeping base. **Padding** CFC-free polyurethane foam with differentiated densities, covered with polyester wadding. **Mattress** Polyurethane foam mattress, 12 cm thick (density 25 kg/m³). **Removable covers** Fully removable upholstery.

Poltrona maxi /
Armchair maxi

Divano due posti /
Two seater sofa

Divano tre posti /
Three seater sofa

Divano tre posti maxi /
Large three seater sofa

Poltrona letto /
Chair bed
70x195 cm

Divano letto
piazza e mezza / Small
double size sofa bed
120x195 cm

Divano letto matrimoniale
piccolo /
Double size sofa bed
140x195 cm

Divano letto matrimoniale
grande /
King size sofa bed
160x195 cm

Profondità seduta / Seating depth 62 cm
Altezza seduta / Seat height 44 cm

Altezza materasso / Mattress height
12 cm (materasso in poliuretano / polyurethane mattress)

Disponibile in versione fissa /
Available sofa without bed

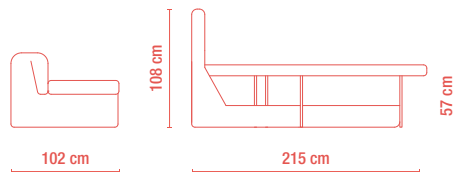
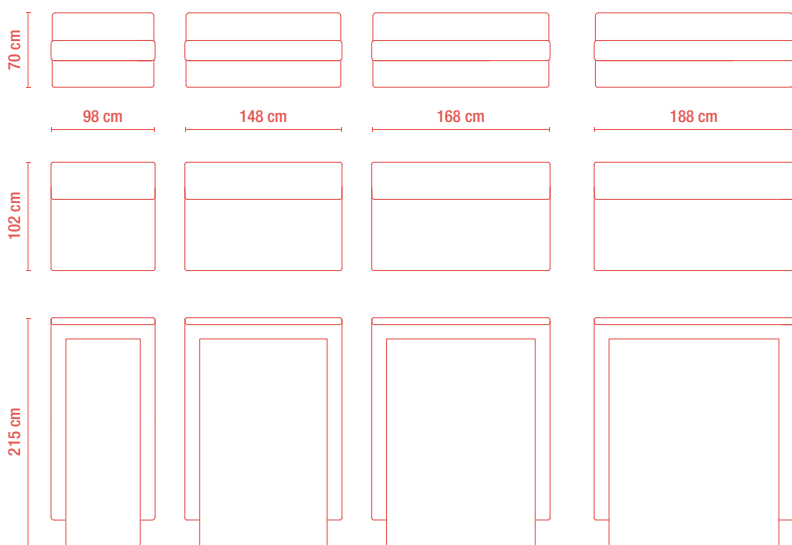

Bracciolo sx/dx /
Left/right arm

Bracciolo lungo sx/dx /
Long left/right arm

Sedile /
Ottoman

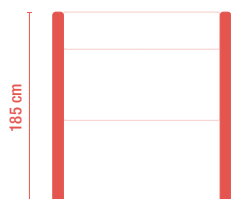

Struttura Inserto in legno rivestito in poliuretano espanso e fibra. **Meccanismo** Meccanismo del letto in acciaio, verniciatura a polveri epossidiche, meccanismo con apertura sincronizzata mediante ribaltamento della spalliera, supporto per dormire in doghe larghe in faggio stratificato anti affossamento. **Imbottitura** Poliuretano espanso senza CFC a quote differenziate e ovatta poliestere. **Materassi** Materasso in poliuretano espanso H 19 cm a una densità 25 kg/m³; Materasso a molle H 19 cm composto da Molleggio Bonnel 2.0 e lastra di espanso FE21 su entrambi i lati; Materasso in memory foam (o schiuma in lattice) H 19 cm. **Sfoderabilità** Divano completamente sfoderabile.

Structure Wooden insert upholstered in polyurethane foam and fibre. **Bed mechanism** Steel bed mechanism with epoxy powder coating and synchronized opening system with backrest tilt; laminated beech wide slats anti-sag sleeping base. **Padding** CFC-free polyurethane foam with differentiated densities, covered with polyester wadding. **Mattresses** Polyurethane foam mattress, 19 cm thick (density 25 kg/m³); Spring mattress, 19 cm thick, with Bonnel 2.0 spring system and FE21 foam layer on both sides; Memory foam (or latex foam) mattress, 19 cm thick. **Removable covers** Fully removable upholstery.

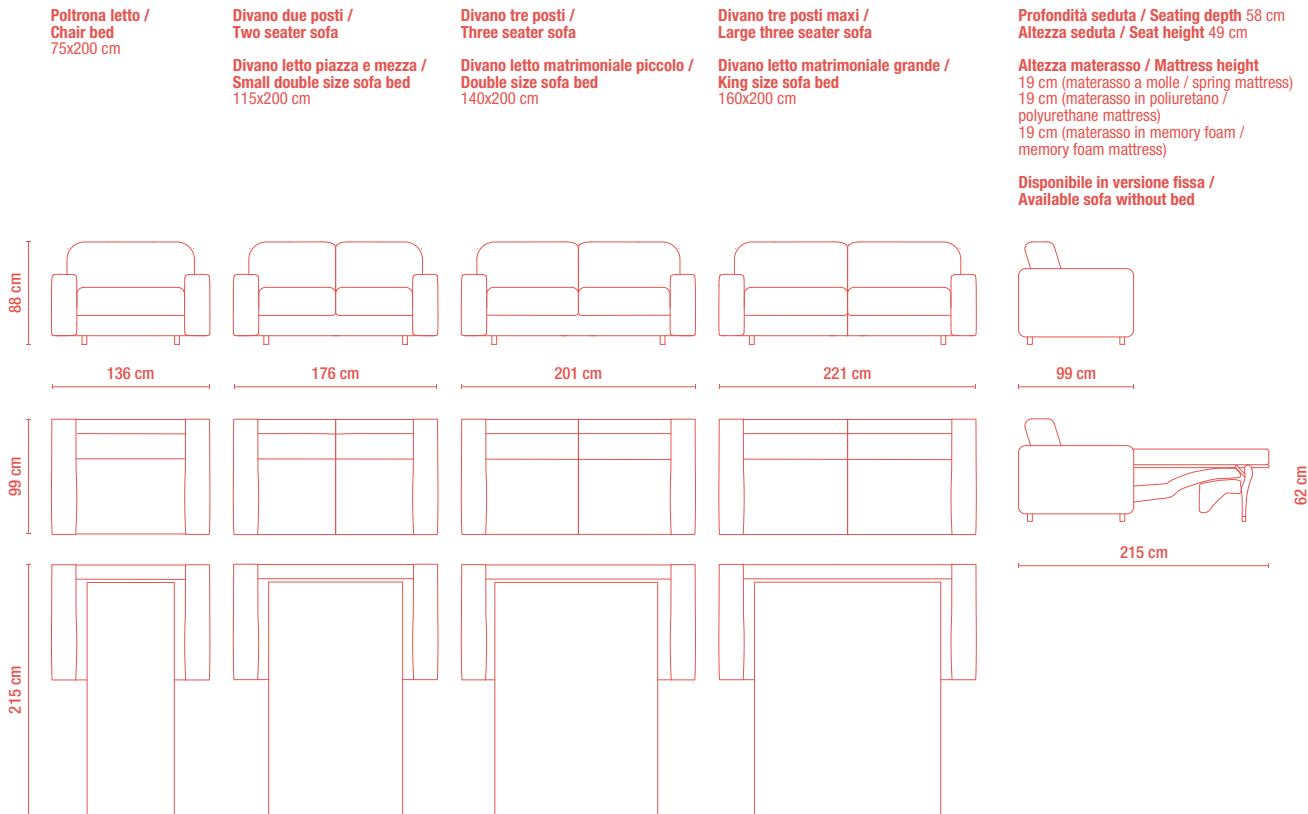

Struttura Inserto in legno rivestito in poliuretano espanso e fibra. **Meccanismo** Meccanismo del letto in acciaio, verniciatura a polveri epossidiche, meccanismo con apertura sincronizzata mediante ribaltamento della spalliera, supporto per dormire in maglia d'acciaio elettrosaldata. **Imbottitura** Poliuretano espanso senza CFC a quote differenziate e ovatta poliestere. **Materassi** Materasso in poliuretano espanso H 12 cm a una densità 25 kg/m³; Materasso a molle H 14 cm composto da Molleggio Bonnel 2.0 e lastra di espanso FE21 su entrambi i lati. **Sfoderabilità** Divano completamente sfoderabile.

Structure Wooden insert upholstered in polyurethane foam and fibre. **Bed mechanism** Steel bed mechanism with epoxy powder coating and synchronized opening system with backrest tilt; electro-welded steel mesh sleeping base. **Padding** CFC-free polyurethane foam with differentiated densities, covered with polyester wadding. **Mattresses** Polyurethane foam mattress, 12 cm thick (density 25 kg/m³); Spring mattress, 14 cm thick, with Bonnel 2.0 spring system and FE21 foam layer on both sides. **Removable covers** Fully removable upholstery.

Divano letto matrimoniale piccolo /
Double size sofa bed
140x200 cm

Divano letto matrimoniale grande /
King size sofa bed
160x200 cm

Profondità seduta / Seating depth 56 cm
Altezza seduta / Seat height 47 cm

Altezza materasso / Mattress height
14 cm (materasso a molle / spring mattress)
12 cm (materasso in poliuretano / polyurethane mattress)

Vano contenitore porta guanciaie / Pillow storage compartment

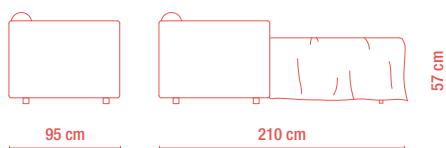
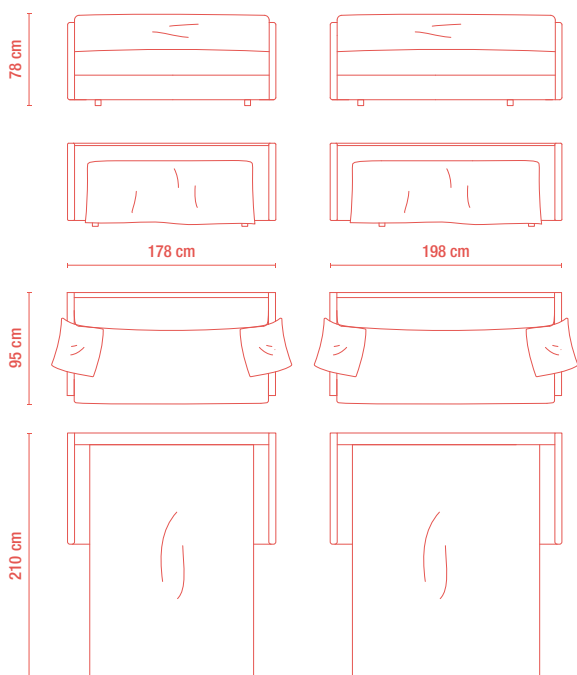

Struttura Struttura in poliuretano espanso. **Imbottitura** Poliuretano espanso senza CFC a quote differenziate e ovatta poliestere. **Rivestimento** Nylon ripstop disponibile in tre colorazioni. **Cinghie** Cinturino in tessuto con clip a sgancio rapido colore nero.

Structure Polyurethane foam structure. **Padding** CFC-free polyurethane foam with differentiated densities, covered with polyester wadding. **Upholstery** Ripstop nylon available in three colours. **Straps** Fabric strap with black quick-release buckle.

Seduta morbida e materasso con trapunta /
Soft seat and mattress with quilt
70x225 cm

Profondità seduta / Seating depth 68 cm
Altezza seduta / Seat height 40 cm

Altezza materasso / Mattress height
12 cm (materasso in poliuretano / polyurethane mattress)

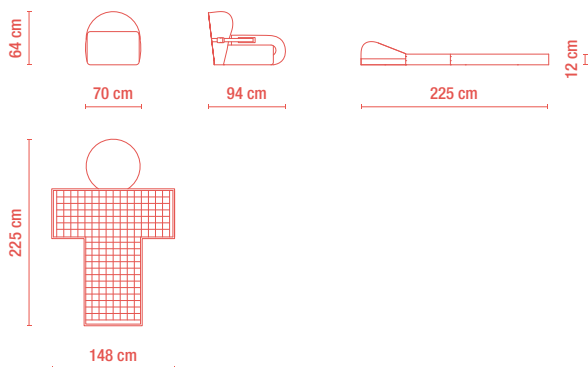

Istante

DESIGNER CAMPEGGI DESIGN

Struttura Struttura in acciaio. **Meccanismo** Meccanismo del letto in acciaio, verniciatura a polveri epossidiche, meccanismo con apertura ad alzata frontale per pronto letto, supporto per dormire in doghe larghe in faggio stratificato anti affossamento. **Imbottitura** Poliuretano espanso senza CFC a quote differenziate e ovatta poliestere. **Piedino** Piedino in legno di faggio H 13 cm. **Materasso** Materasso in poliuretano espanso H 12 cm a una densità 25 kg/m³. **Sfoderabilità** Divano completamente sfoderabile.

Structure Steel frame. **Bed mechanism** Steel bed mechanism with epoxy powder coating and front lifting opening system for ready-bed use; laminated beech wide slats anti-sag sleeping base. **Padding** CFC-free polyurethane foam with differentiated densities, covered with polyester wadding. **Feet** Beech wood feet, 13 cm high. **Mattress** Polyurethane foam mattress, 12 cm thick (density 25 kg/m³). **Removable covers** Fully removable upholstery.

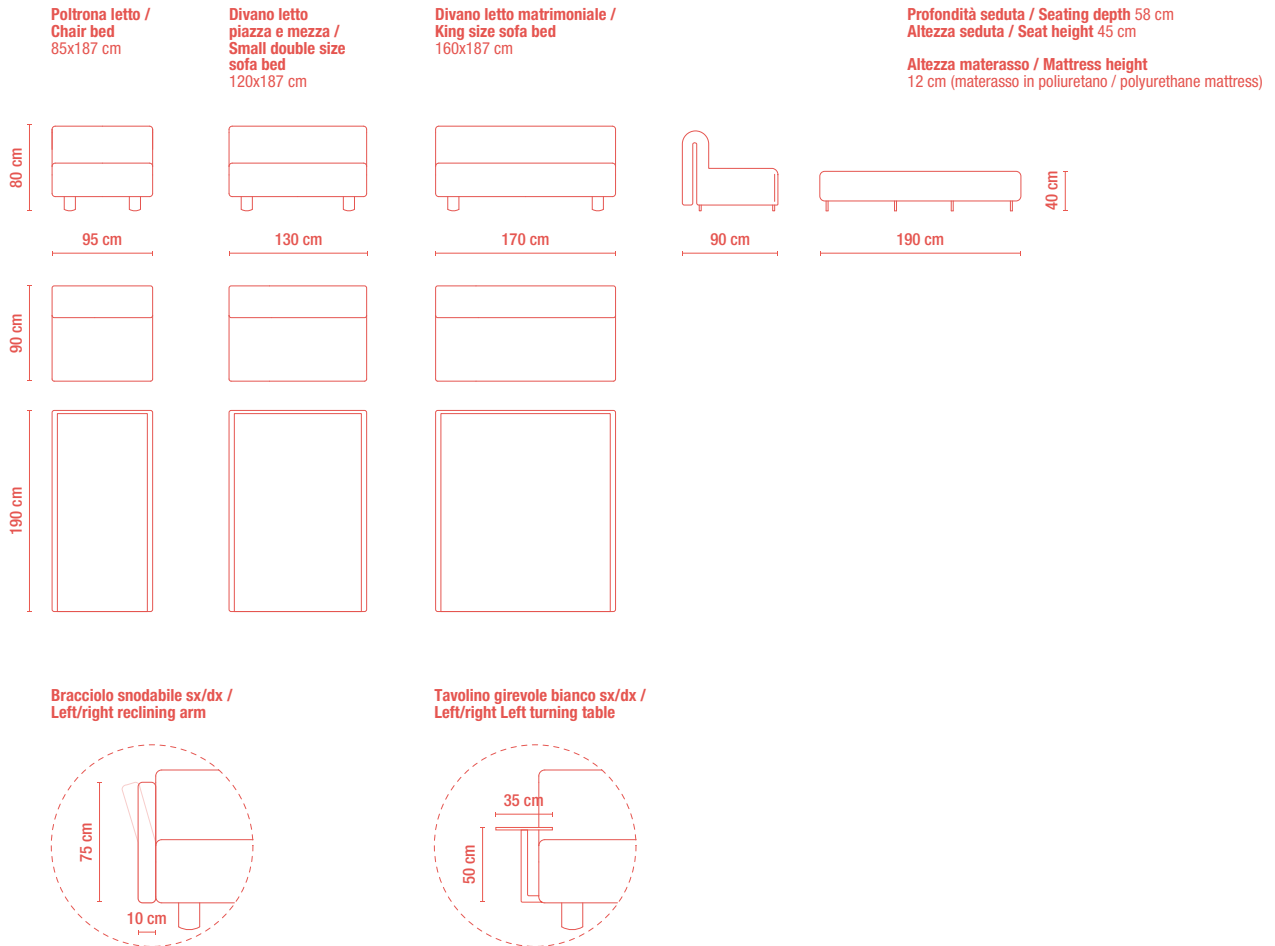

Kai

DESIGNER SAKURA ADACHI

Struttura Struttura in acciaio verniciato bianco e feltro. **Ferramenta** Acciaio verniciato.

Structure White-painted steel frame with felt. **Hardware** Painted steel.

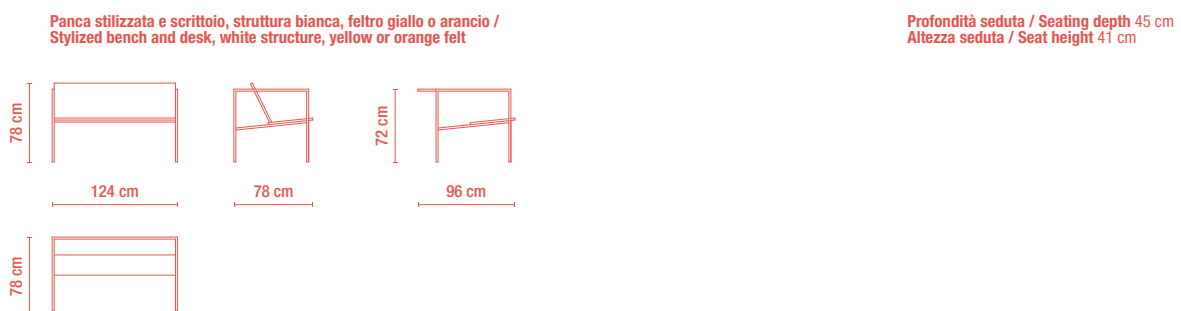

Lazy Basketball

DESIGNER EMANUELE MAGINI

Struttura Struttura in acciaio verniciato bianco e corda colore giallo o rosso. **Structure** White-painted steel frame with yellow or red rope.

Seduta con canestro bianco rete giallo o rosso /
Seat with white structure yellow or red net

Profondità seduta / Seating depth 50 cm
Altezza seduta / Seat height 44 cm

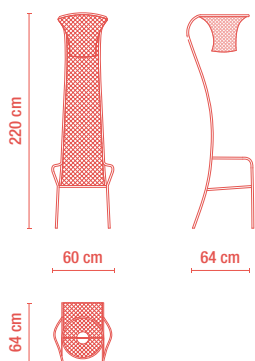

Le Temps de la Communauté

DESIGNER MATALI CRASSET

Struttura Polistirolo espanso 30 Kg/m³ rivestito in poliuretano espanso a quote differenziate. **Connessione** 3 magneti a lato per modulo due punti inferiori - un punto superiore. **Imbottitura** Fibra poliestere 100 gr/m². **Rivestimento** Ecopelle sui due lati, lana/cotone sui fronti. **Sfoderabilità** Completamente sfoderabile.

Structure 30 kg/m³ expanded polystyrene covered with polyurethane foam at different densities. **Connection** 3 magnets per side per module (two lower - one upper). **Padding** Polyester fiber m². **Upholstery** Faux leather on the two sides, wool/cotton on the fronts. **Removability** Completely removable cover.

Poltrona/Divano componibile 2 elementi (ordine minimo) /
Armchair/sofa 2 elements (minimum order)

Profondità seduta / Seating depth 38 cm
Altezza seduta / Seat height 40 cm

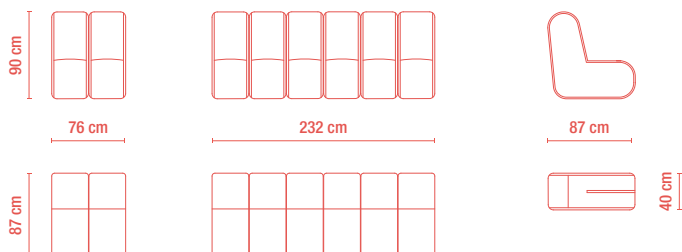

Struttura Inserto in legno rivestito in poliuretano espanso e fibra. **Meccanismo** Meccanismo del letto in acciaio, verniciatura a polveri epossidiche, meccanismo con apertura sincronizzata mediante ribaltamento della spaliera, supporto per dormire in doghe larghe in faggio stratificato anti affossamento. **Imbottitura** Poliuretano espanso senza CFC a quote differenziate e ovatta poliester. **Piedino** Fascia in acciaio cromato. **Materassi** Materasso in poliuretano espanso H 19 cm a una densità 25 kg/m³; Materasso a molle H 19 cm composto da Molleggio Bonnel 2.0 e lastra di espanso FE21 su entrambi i lati; Materasso in memory foam (o schiuma in lattice) H 19 cm. **Sfoderabilità** Divano completamente sfoderabile.

Structure Wooden insert upholstered in polyurethane foam and fibre. **Bed mechanism** Steel bed mechanism with epoxy powder coating and synchronized opening system with backrest tilt; laminated beech wide slats anti-sag sleeping base. **Padding** CFC-free polyurethane foam with differentiated densities, covered with polyester wadding. **Feet** Chrome-plated steel band. **Mattresses** Polyurethane foam mattress, 19 cm thick (density 25 kg/m³); Spring mattress, 19 cm thick, with Bonnel 2.0 spring system and FE21 foam layer on both sides; Memory foam (or latex foam) mattress, 19 cm thick. **Removable covers** Fully removable upholstery.

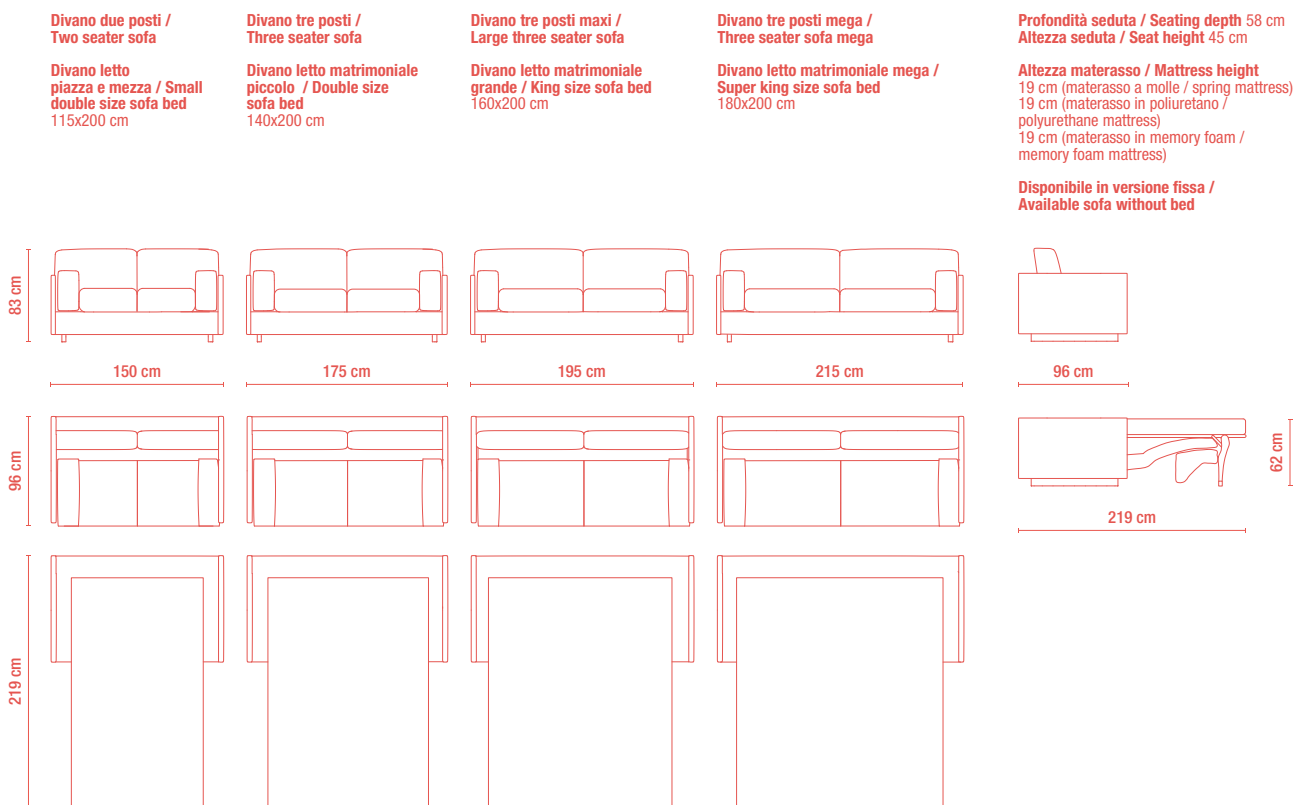

Maracanà

Struttura Inserto in acciaio rivestito in poliuretano espanso e fibra. **Mecanismo** Meccanismo del letto in poliuretano, meccanismo con ruote ad estrazione e ribaltamento dello schienale (secondo gradone). **Imbottitura** Poliuretano espanso senza CFC a quote differenziate e ovatta poliester. **Sfoderabilità** Divano completamente sfoderabile.

Structure Steel insert upholstered in polyurethane foam and fibre. **Bed mechanism** Polyurethane bed mechanism with pull-out castors and backrest fold-down (second step). **Padding** CFC-free polyurethane foam with differentiated densities, covered with polyester wadding. **Removable covers** Fully removable upholstery.

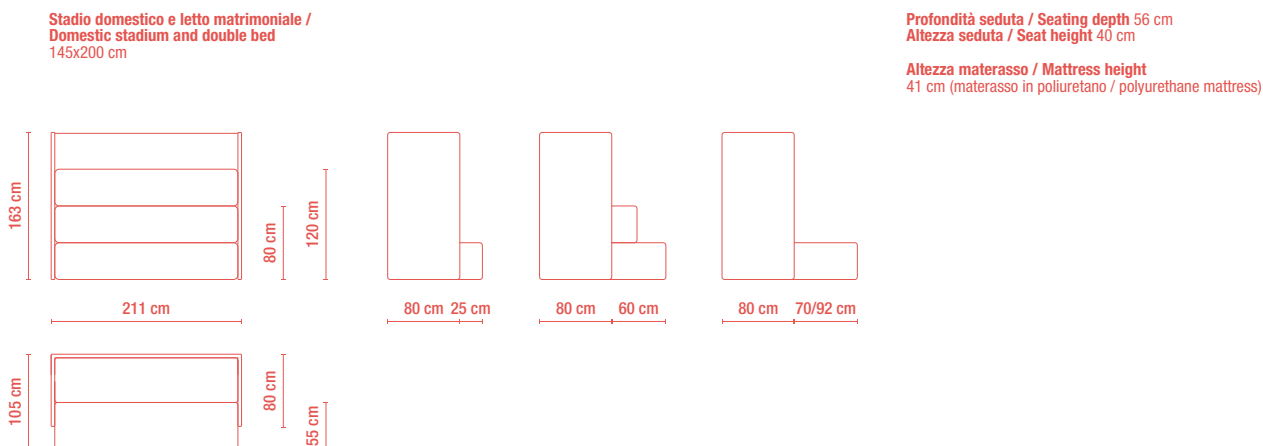

Matrix

DESIGNER GIULIO MANZONI

Struttura Inserto in legno rivestito in poliuretano espanso e fibra. **Meccanismo** Meccanismo del letto in acciaio, verniciatura a polveri epossidiche, meccanismo con apertura sincronizzata mediante ribaltamento della spalliera, supporto per dormire in maglia d'acciaio elettrosaldata. **Imbottitura** Poliuretano espanso senza CFC a quote differenziate e ovatta poliestere. **Piedino** Piedino in acciaio brunito H 8 cm. **Materassi** Materasso in poliuretano espanso H 12 cm a una densità 25 kg/m³; Materasso a molle H 14 cm con rinforzo in poliuretano sul lato superiore. **Sfoderabilità** Divano completamente sfoderabile.

Structure Wooden insert upholstered in polyurethane foam and fibre. **Bed mechanism** Steel bed mechanism with epoxy powder coating and synchronized opening system with backrest tilt; electro-welded steel mesh sleeping base. **Padding** CFC-free polyurethane foam with differentiated densities, covered with polyester wadding. **Feet** Burnished steel feet, 8 cm high. **Mattresses** Polyurethane foam mattress, 12 cm thick (density 25 kg/m³); Spring mattress, 14 cm thick, with polyurethane reinforcement on the top side. **Removable covers** Fully removable upholstery.

Divano letto matrimoniale piccolo /
Double size sofa bed
140x200 cm

Divano letto matrimoniale grande /
King size sofa bed
160x200 cm

Profondità seduta / Seating depth 60 cm
Altezza seduta / Seat height 47 cm

Altezza materasso / Mattress height
14 cm (materasso a molle / spring mattress)
12 cm (materasso in poliuretano / polyurethane mattress)

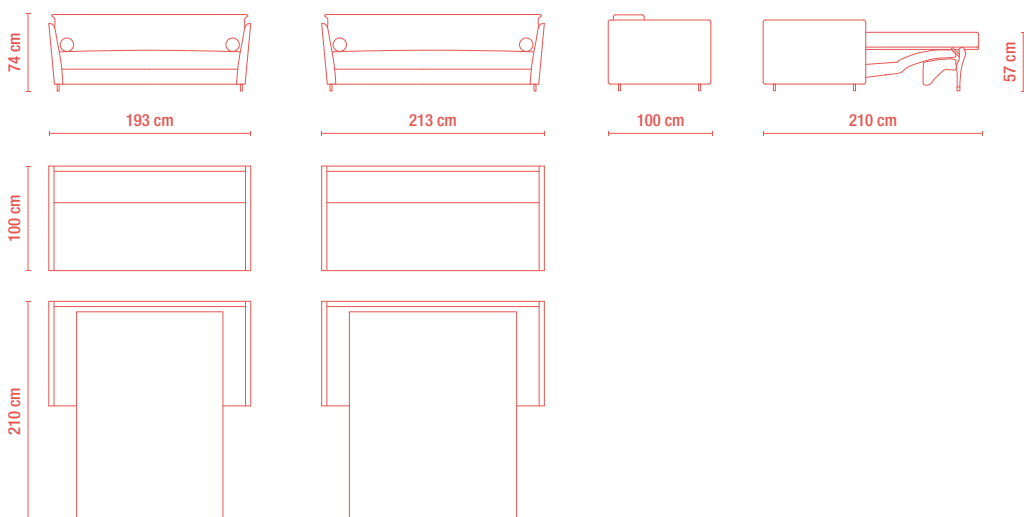

Mehari

DESIGNER DAVIDE BIANCUCCI

Struttura Legno in frassino naturale verniciato con finitura acrilica trasparente per l'esterno. **Ferramenta** Acciaio Inox verniciato nero. **Tessuto** Canvas idrorepellente e autoportante 100% cotone / peso 480 gr. **NB** per garantire durabilità nel tempo è consigliabile il posizionamento su terrazze o verande. Non piegare o ripiegare il tessuto bagnato per tempi prolungati. Si suggerisce lo spostamento e/o la rotazione dell'elemento dopo periodi di piogge e forte umidità.

Structure Natural ash wood, varnished with transparent acrylic outdoor finish. **Hardware** Black-painted stainless steel. **Fabric** Water-repellent, self-supporting canvas, 100% cotton, weight 480 g. **Note** To ensure long-term durability, placement on terraces or verandas is recommended. Do not fold or store the fabric while wet for extended periods. It is advisable to move and/or rotate the element after periods of heavy rain or high humidity.

Poltroncina /
Folding chair

Profondità seduta / Seating depth 56 cm
Altezza seduta / Seat height 40 cm

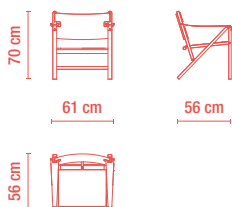

Micia

DESIGNER PAOLO IMPERATORI

Struttura Struttura in acciaio rivestita in poliuretano espanso e fibra. **Mecanismo** Meccanismo del letto in acciaio, verniciatura a polveri epossidiche, meccanismo con apertura frontale a piani sovrapposti, supporto per dormire in maglia d'acciaio elettrosaldato. **Imbottitura** Poliuretano espanso senza CFC a quote differenziate e ovatta poliestere. **Materasso** Materasso in poliuretano espanso H 10 cm a una densità 25 kg/m³. **Sfoderabilità** Poltrona completamente sfoderabile.

Structure Steel frame upholstered in polyurethane foam and fibre. **Bed mechanism** Steel bed mechanism with epoxy powder coating and front-opening mechanism with overlapping panels; electro-welded steel mesh sleeping base. **Padding** CFC-free polyurethane foam with differentiated densities, covered with polyester wadding. **Mattress** Polyurethane foam mattress, 10 cm thick (density 25 kg/m³). **Removable covers** Fully removable upholstery.

Poltrona letto /
Chair bed
75x198 cm

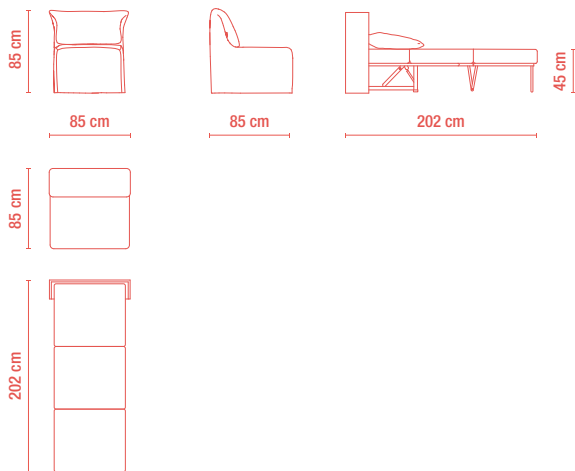

Profondità seduta / Seating depth 60 cm
Altezza seduta / Seat height 48 cm

Altezza materasso / Mattress height
10 cm (materasso in poliuretano / polyurethane mattress)

Moby

DESIGNER CAMPEGGI DESIGN

Struttura Struttura in acciaio rivestito in tessuto trapuntato. **Piano** Pianetto in legno nobilitato bianco. **Meccanismo** Meccanismo del letto in acciaio, verniciatura a polveri epossidiche, meccanismo con apertura a libro, supporto per dormire in maglia d'acciaio elettrosaldato. **Materasso** Materasso in poliuretano espanso H 11 cm a una densità 25 kg/m³. **Sfoderabilità** Struttura completamente sfoderabile.

Structure Steel frame upholstered in quilted fabric. **Top** White melamine-coated wood top. **Bed mechanism** Steel bed mechanism with epoxy powder coating and book-style opening system; electro-welded steel mesh sleeping base. **Mattress** Polyurethane foam mattress, 11 cm thick (density 25 kg/m³). **Removable covers** Structure fully removable.

Contenitore per letto singolo /
Small single bed box
75x185 cm

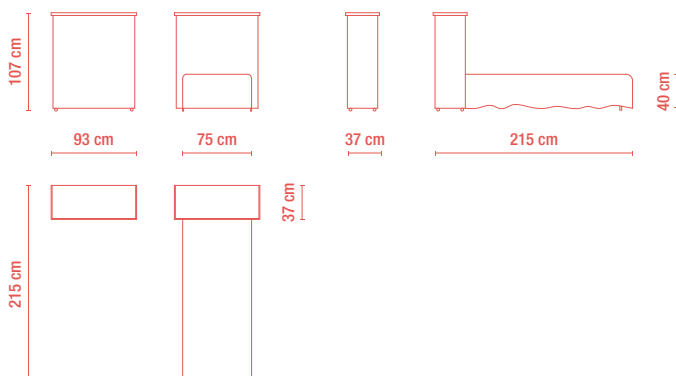

Altezza materasso / Mattress height
11 cm (materasso in poliuretano / polyurethane mattress)

Struttura Legno in faggio evaporato verniciato trasparente. **Ferramenta** metallo verniciato nero.

Structure Steamed beech wood painted transparent. **Steel Structure** Painted black metal.

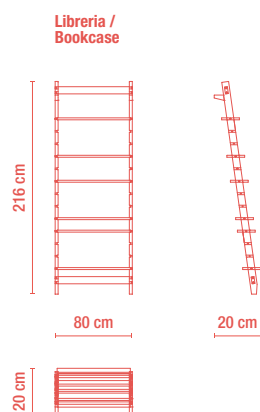

Nuvo

DESIGNER PAOLO IMPERATORI

Struttura Struttura in acciaio verniciato nero o bianco e legno rivestito in poliuretano espanso e fibra. **Meccanismo** Meccanismo del letto in acciaio, verniciatura a polveri epossidiche, meccanismo con rotazione degli elementi da schienale a bracciolo e/o cuscino. **Imbottitura** Poliuretano espanso senza CFC a quote differenziate e ovatta poliestere. **Sfoderabilità** Divano completamente sfoderabile.

Structure Black or white painted steel frame with wooden elements upholstered in polyurethane foam and fibre. **Bed mechanism** Steel bed mechanism with epoxy powder coating and rotating system allowing backrest elements to transform into armrests and/or cushions. **Padding** CFC-free polyurethane foam with differentiated densities, covered with polyester wadding. **Removable covers** Fully removable upholstery.

Divano letto singolo struttura bianco o nero /
Small single sofa bed white or black structure
92x202 cm

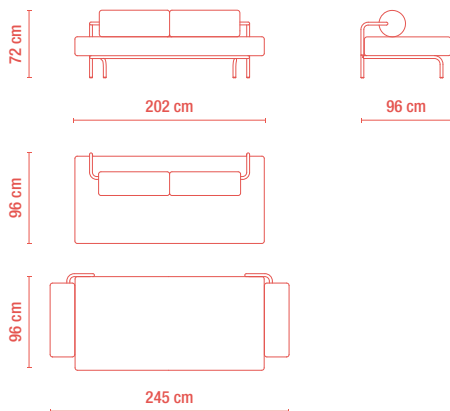

Profondità seduta / Seating depth 56 cm
Altezza seduta / Seat height 44 cm

Altezza materasso / Mattress height
18 cm (materasso in poliuretano / polyurethane mattress)

Struttura Inserto in legno rivestito in poliuretano espanso e fibra. **Meccanismo** Meccanismo del letto in acciaio, verniciatura a polveri epossidiche, meccanismo con sistema di apertura a sollevamento frontale a due tempi, supporto per dormire in maglia d'acciaio elettrosaldato. **Imbottitura** Poliuretano espanso senza CFC a quote differenziate e ovatta poliestere. **Materasso** Materasso a molle H 12 cm composto da Molleggio Bonnel 2.0, feltro morbido 1200gr/m³ su entrambi i lati, lastra di espanso FE21 su un lato. **Sfoderabilità** Divano completamente sfoderabile.

Structure Wooden insert upholstered in polyurethane foam and fibre. **Bed mechanism** Steel bed mechanism with epoxy powder coating and two-stage front lifting opening system; electro-welded steel mesh sleeping base. **Padding** CFC-free polyurethane foam with differentiated densities, covered with polyester wadding. **Mattress** Spring mattress, 12 cm thick, with Bonnel 2.0 spring system, soft felt 1200 g/m³ on both sides, and FE21 foam layer on one side. **Removable covers** Fully removable upholstery.

Divano tre posti con due braccioli /
Three seater sofa with 2 arms

Divano tre posti maxi con due braccioli /
Large three seater sofa with 2 arms

Profondità seduta / Seating depth 53 cm
Altezza seduta / Seat height 38 cm

Divano letto matrimoniale piccolo
con due braccioli /
Double size sofa bed with 2 arms
140x195 cm

Divano letto matrimoniale grande
con due braccioli /
King size sofa bed with 2 arms
160x195 cm

Altezza materasso / Mattress height
12 cm (materasso a molle / spring mattress)

Disponibile in versione fissa / Available sofa without bed

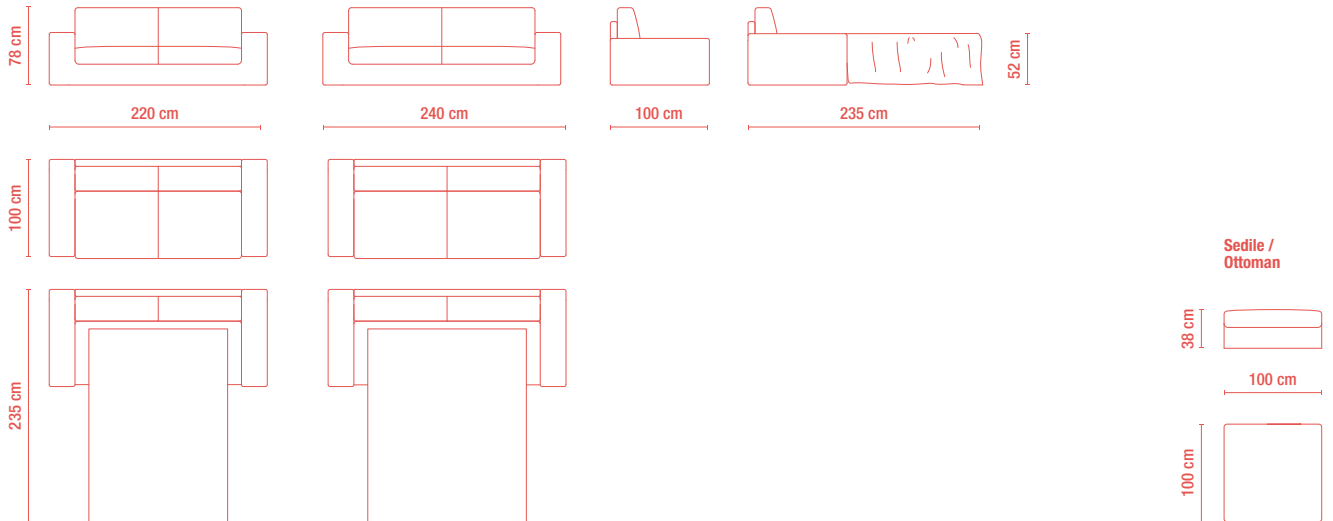

Poltrona stretta con
bracciolo sx/dx /
Narrow chair with
1 left/right arm

Poltrona larga con
bracciolo sx/dx /
Large chair with
1 left/right arm

Divano tre posti con bracciolo
sx/dx / Three seater sofa with
1 left/right arm

Divano tre posti maxi con bracciolo
sx/dx / Large three seater sofa
with 1 left/right arm

Divano letto matrimoniale
piccolo con bracciolo sx/dx /
Double size sofa bed
with 1 left/right arm
140x195 cm

Divano letto matrimoniale grande
con bracciolo sx/dx /
King size sofa bed with
1 left/right arm
160x195 cm

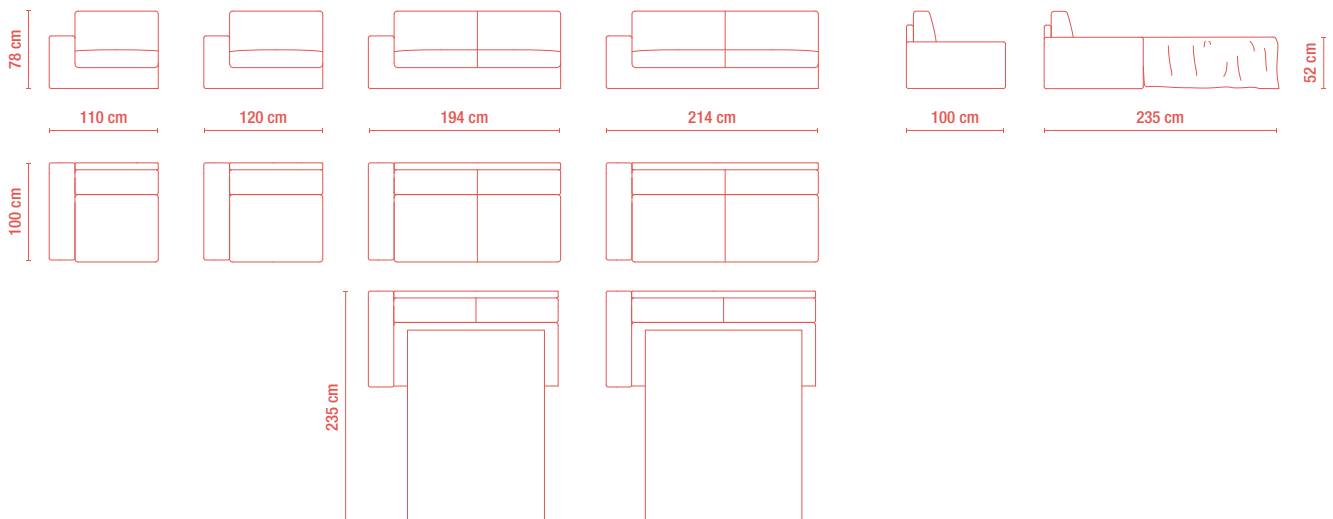

**Poltrona stretta
senza braccioli /
Narrow chair
without arms**

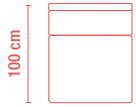
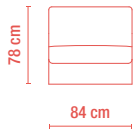

**Poltrona larga
senza braccioli /
Large chair
without arms**



**Divano tre posti senza
braccioli / Three seater
sofa without arms**

**Divano letto matrimoniale
piccolo senza braccioli /
Double size sofa bed
without arms
140x195 cm**

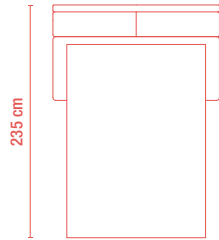
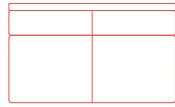
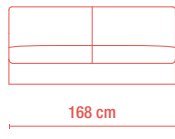

**Divano tre posti maxi senza
braccioli / Large three seater
sofa without arms**

**Divano letto matrimoniale
grande senza braccioli /
King size sofa bed without arms
160x195 cm**

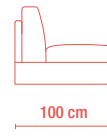
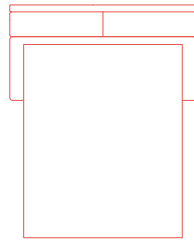
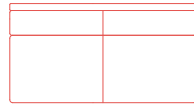
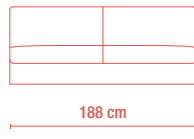

**Angolo /
Corner element**

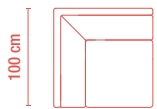
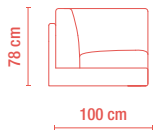

**Poltrona lunga stretta
con bracciolo sx/dx /
Narrow chaise longue
with 1 left/right arm**

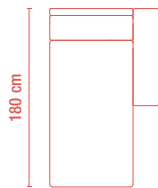
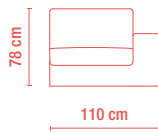

**Poltrona lunga larga
con bracciolo sx/dx /
Large chaise longue
with 1 left/right arm**

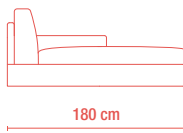
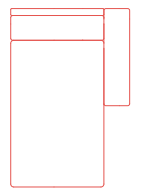
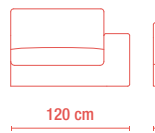

**Poltrona lunga stretta
senza braccioli /
Narrow chaise longue
without arms**

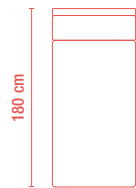
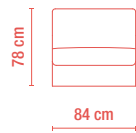

**Poltrona lunga larga
senza braccioli /
Large chaise longue
without arms**

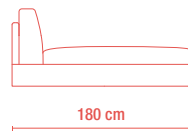
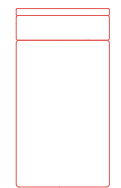

Struttura Inserto in legno rivestito in poliuretano espanso e fibra. **Meccanismo** Meccanismo del letto in acciaio, verniciatura a polveri epossidiche, meccanismo con sistema di apertura a sollevamento frontale a due tempi, supporto per dormire in maglia d'acciaio elettrosaldato. **Imbottitura** Poliuretano espanso senza CFC a quote differenziate e ovatta poliestere. **Piedino** Piedino cilindrico in alluminio satinato H 13 cm. **Materasso** Materasso a molle H 12 cm composto da Molleggio Bonnel 2.0, feltro morbido 1200gr/m³ su entrambi i lati, lastra di espanso FE21 su un lato. **Sfoderabilità** Divano completamente sfoderabile.

Structure Wooden insert upholstered in polyurethane foam and fibre. **Bed mechanism** Steel bed mechanism with epoxy powder coating and two-stage front lifting opening system; electro-welded steel mesh sleeping base. **Padding** CFC-free polyurethane foam with differentiated densities, covered with polyester wadding. **Feet** Satin-finished aluminium cylindrical feet, 13 cm high. **Mattress** Spring mattress, 12 cm thick, with Bonnel 2.0 spring system, soft felt 1200 g/m³ on both sides, and FE21 foam layer on one side. **Removable covers** Fully removable upholstery.

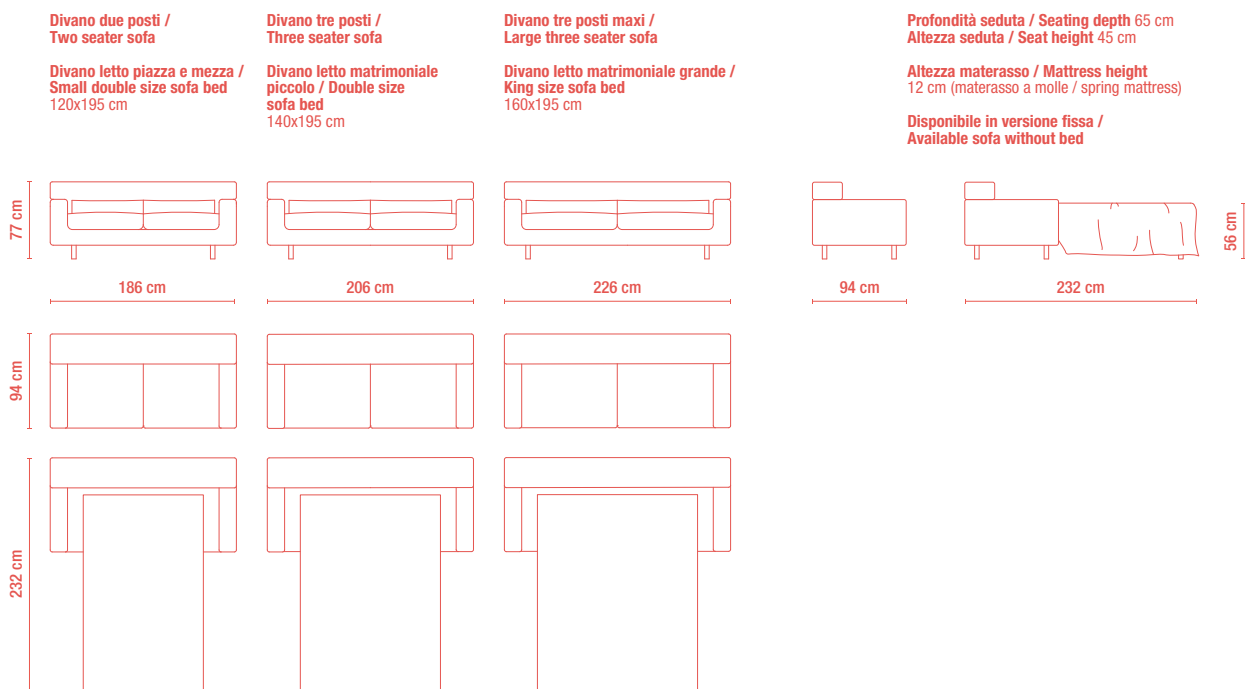

Struttura Struttura in metallo tubolare verniciato, rivestito in poliuretano a differenti densità. **Meccanismo** Meccanismo del letto in acciaio, verniciatura a polveri epossidiche, meccanismo con apertura a pettine, supporto per dormire in doghe di faggio stratificato anti affossamento. **Imbottitura** Poliuretano espanso senza CFC a quote differenziate e ovatta poliestere. **Piedino** Piedino in acciaio H 16 cm. **Materasso** Letto singolo Materasso H 20 cm in poliuretano espanso a una densità 25 Kg/m³; Letto doppio Materasso H 10 cm in poliuretano espanso a una densità Kg/m³. **Sfoderabilità** Divano completamente sfoderabile.

Structure Painted tubular metal frame upholstered in polyurethane foam with differentiated densities. **Bed mechanism** Steel bed mechanism with epoxy powder coating and comb-style opening system; laminated beech slats anti-sag sleeping base. **Padding** CFC-free polyurethane foam with differentiated densities, covered with polyester wadding. **Feet** Steel feet, 16 cm high. **Mattress** Single bed Polyurethane foam mattress, 20 cm thick (density 25 kg/m³); Double bed Polyurethane foam mattress, 10 cm thick (density to be defined). **Removable covers** Fully removable upholstery.

Divano letto singolo e matrimoniale /
Small single sofa bed and double size sofa bed
68x202 cm
136x202 cm

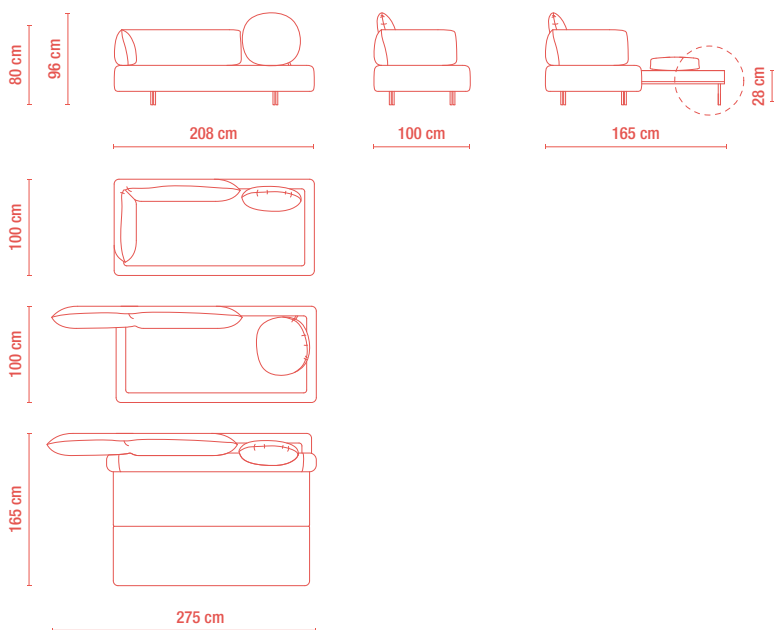

Profondità seduta / Seating depth 70 cm
Altezza seduta / Seat height 42 cm

Altezza materasso / Mattress height
20 cm (materasso in poliuretano / polyurethane mattress)
10 cm (materasso in poliuretano / polyurethane mattress)

Fuoriuscita materasso /
Mattress overhang
14 cm rispetto alla struttura /
14 cm beyond the frame

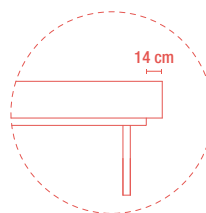

Struttura Inserto in legno rivestito in poliuretano espanso e fibra. **Meccanismo** Meccanismo del letto in acciaio, verniciatura a polveri epossidiche, meccanismo ad estrazione dotato di sistema di sollevamento semiautomatico mediante maniglia, supporto per dormire in doghe larghe in faggio stratificato anti affossamento. **Imbottitura** Poliuretano espanso senza CFC a quote differenziate e ovatta poliestere. **Materassi** Materasso in poliuretano espanso H 14 cm a una densità 25 kg/m³; Materasso a molle H 14 cm con rinforzo in poliuretano sul lato superiore; Materasso in memory foam (o schiuma in lattice) H 19 cm. **Sfoderabilità** Divano completamente sfoderabile.

Structure Wooden insert upholstered in polyurethane foam and fibre. **Bed mechanism** Steel bed mechanism with epoxy powder coating and pull-out system featuring a semi-automatic lifting mechanism operated by handle; laminated beech wide slats anti-sag sleeping base. **Padding** CFC-free polyurethane foam with differentiated densities, covered with polyester wadding. **Mattresses** Polyurethane foam mattress, 14 cm thick (density 25 kg/m³); Spring mattress, 14 cm thick, with polyurethane reinforcement on the top side; Memory foam (or latex foam) mattress, 19 cm thick. **Removable covers** Fully removable upholstery.

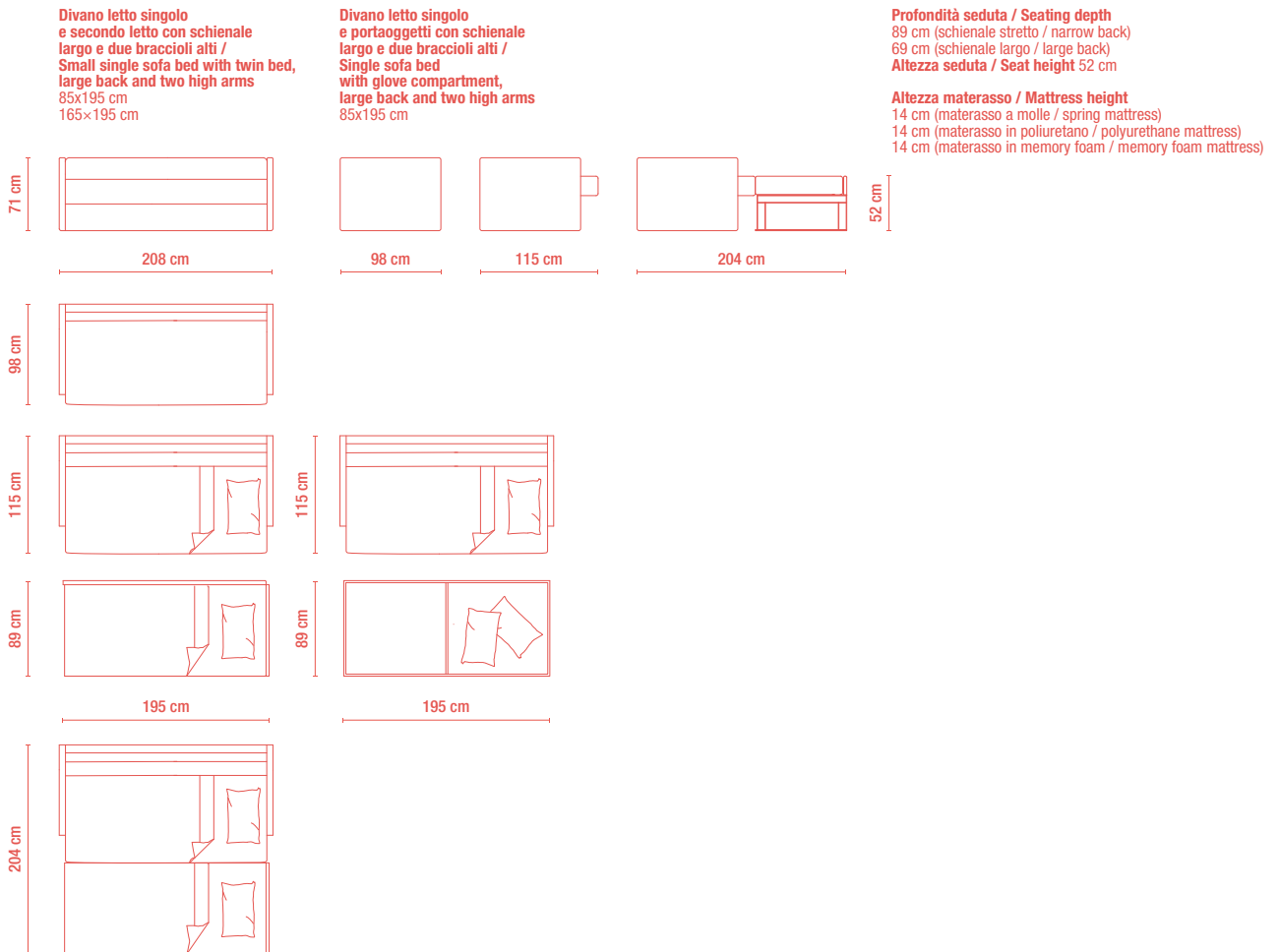

Divano letto singolo e secondo letto con schienale stretto e due braccioli alti / Small single sofa bed with twin bed, narrow back and two high arms
85x195 cm
165x195 cm

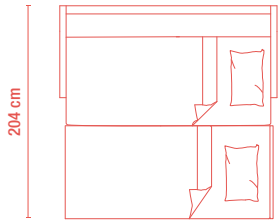
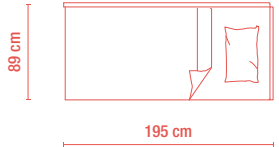

Divano letto singolo e portaoggetti con schienale stretto e due braccioli alti / Single sofa bed with glove compartment, narrow back and two high arms
85x195 cm

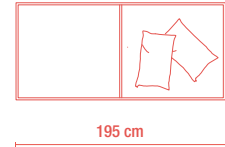
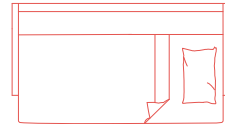
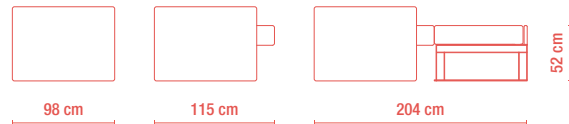

Divano letto singolo e secondo letto con schienale stretto e bracciolo alto sx/dx / Small single sofa bed with twin bed, narrow back and 1 left/right arm
85x195 cm
165x195 cm

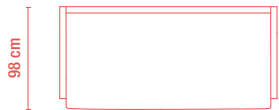

Divano letto singolo e secondo letto con schienale stretto senza braccioli alti / Small single sofa bed with twin bed, narrow back without arms
85x195 cm
165x195 cm

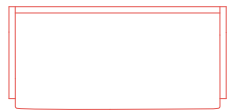

Divano letto singolo e secondo letto senza schienale stretto con due braccioli alti / Small single sofa bed with twin bed, two high arms, without back
85x195 cm
165x195 cm

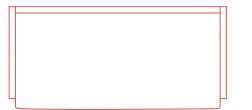

Divano letto singolo e secondo letto senza schienale stretto con bracciolo alto sx/dx / Small single sofa bed with twin bed, 1 left/right arm, without back
85x195 cm
165x195 cm



Divano letto singolo e secondo letto senza schienale stretto senza braccioli alti / Small single sofa bed with twin bed, without back, without arms
85x195 cm
165x195 cm

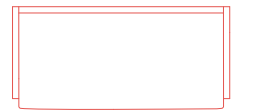

Divano letto singolo e portaoggetti con schienale stretto e bracciolo alto sx/dx / Single sofa bed with glove compartment, narrow back and 1 left/right arm
85x195 cm

Divano letto singolo e portaoggetti con schienale stretto senza braccioli alti / Single sofa bed with glove compartment, narrow back without arms
85x195 cm

Divano letto singolo e portaoggetti senza schienale stretto con due braccioli alti / Single sofa bed with glove compartment, two high arms, without back
85x195 cm

Divano letto singolo e portaoggetti senza schienale stretto con bracciolo alto sx/dx / Single sofa bed with glove compartment, 1 left/right arm, without back
85x195 cm

Divano letto singolo e portaoggetti senza schienale stretto senza braccioli alti / Small single sofa bed with glove compartment, without back, without arms
85x195 cm

Oops

DESIGNER GIULIO MANZONI

Struttura Struttura in acciaio rivestita in poliuretano espanso e fibra. **Mecanismo** Meccanismo del letto in acciaio, verniciatura a polveri epossidiche, meccanismo con apertura frontale a piani sovrapposti, supporto per dormire in maglia d'acciaio elettrosaldata, meccanismo schienale con apertura mediante cric. **Imbottitura** Poliuretano espanso senza CFC a quote differenziate e ovatta poliestere. **Materasso** Materasso in poliuretano espanso H 10 cm a una densità 25 kg/m³. **Sfoderabilità** Poltrona completamente sfoderabile.

Structure Steel frame upholstered in polyurethane foam and fibre. **Bed mechanism** Steel bed mechanism with epoxy powder coating and front-opening mechanism with overlapping panels; electro-welded steel mesh sleeping base; backrest mechanism with ratchet opening system. **Padding** CFC-free polyurethane foam with differentiated densities, covered with polyester wadding. **Mattress** Polyurethane foam mattress, 10 cm thick (density 25 kg/m³). **Removable covers** Fully removable upholstery.

Poltrona letto singolo e secondo letto /
Small single chair bed with twin bed
71×201 cm
139×201 cm

Profondità seduta / Seating depth 58 cm
Altezza seduta / Seat height 45 cm

Altezza materasso / Mattress height
10 cm (materasso in poliuretano / polyurethane mattress)

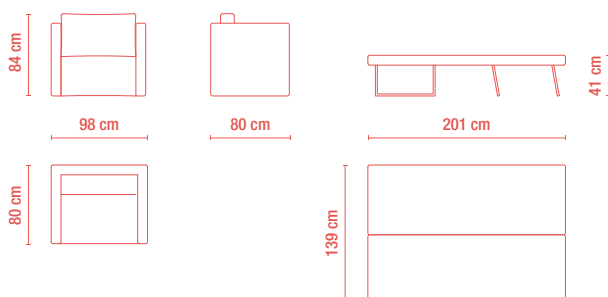

Ospite

DESIGNER VICO MAGISTRETTI

Struttura Legno in acero naturale cerato e faggio naturale. **Tessuto** strutturale in juta. **Ferramenta** Metallo verniciato. **Tessuto** Tessuto cuscini e materasso 100% cotone / cotone + poliestere / poliestere presente all'interno della cartella colori. **Schienale** barra in acero diametro 4 cm verniciato blu scuro.

Structure Waxed natural maple and natural beech wood; structural jute fabric. **Hardware** Painted metal. **Fabric** Cushion and mattress fabrics in 100% cotton / cotton + polyester / polyester, as per the available colour card. **Backrest** Maple bar, Ø 4 cm, dark blue painted finish.

Letto pieghevole in acero naturale cerato /
Folding bed waxed natural maple wood structure
77×190 cm

Profondità seduta / Seating depth 63 cm
Altezza seduta / Seat height 43 cm

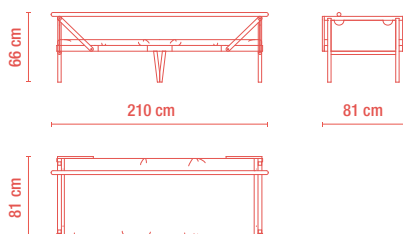

Struttura Inserto in legno rivestito in poliuretano espanso e fibra. **Meccanismo** Meccanismo del letto in acciaio, verniciatura a polveri epossidiche, meccanismo con apertura sincronizzata mediante ribaltamento della spalliera, supporto per dormire in maglia d'acciaio elettrosaldata. **Imbottitura** Poliuretano espanso senza CFC a quote differenziate e ovatta poliestere. **Materasso** Materasso in poliuretano espanso H 16 cm a una densità 25 kg/m³. **Sfoderabilità** Divano completamente sfoderabile.

Structure Wooden insert upholstered in polyurethane foam and fibre. **Bed mechanism** Steel bed mechanism with epoxy powder coating and synchronized opening system with backrest tilt; electro-welded steel mesh sleeping base. **Padding** CFC-free polyurethane foam with differentiated densities, covered with polyester wadding. **Mattress** Polyurethane foam mattress, 16 cm thick (density 25 kg/m³). **Removable covers** Fully removable upholstery.

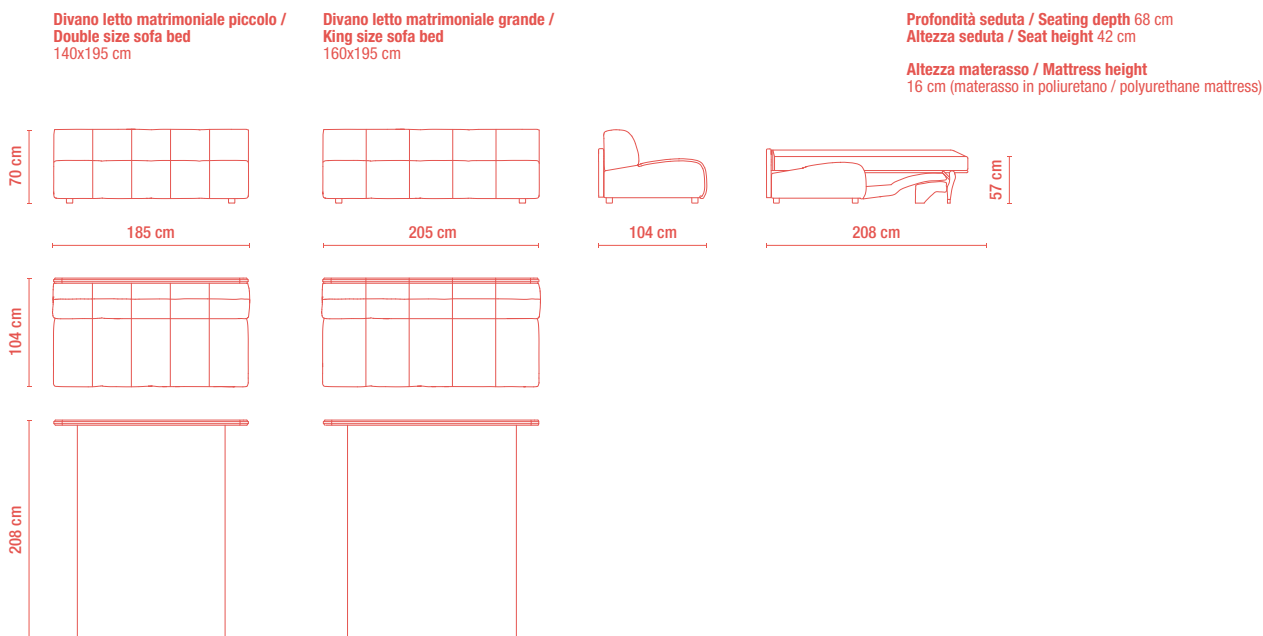

Piccy

Struttura Legno in faggio evaporato verniciato trasparente. **Ferramenta** Metallo verniciato in finitura micacea. **Tessuto** Canvas idrorepellente e autoportante 75% CO 25% PP.

Structure Evaporated beech wood painted natural. **Steel structure** Painted metal with micaceous finish. **Fabric** Water repellent and self supporting Canvas 75% CO 25% PP.

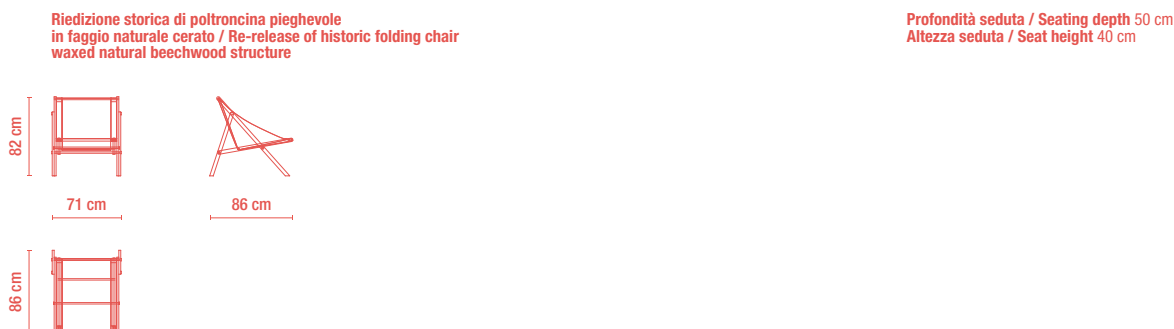

Pisola

DESIGNER DENIS SANTACHIARA

Struttura Struttura schiumato espanso con inserto in ferro, rivestito in fibra poliestere e lycra. **Materassino** Materassino gonfiabile in PVC con pompa integrata H 20 cm, tecnologia in fibertech, peso massimo supportato 120 kg. Tempo di gonfiaggio 3 min circa. **Sfoderabilità** Materasso completamente sfoderabile.

Structure Moulded foam structure with steel insert, upholstered in polyester fibre and Lycra. **Mattress pad** Inflatable PVC mattress pad with integrated pump, 20 cm high, FiberTech™ technology, maximum supported weight 120 kg, approx. 3-minute inflation time. **Removable covers** Mattress pad fully removable.

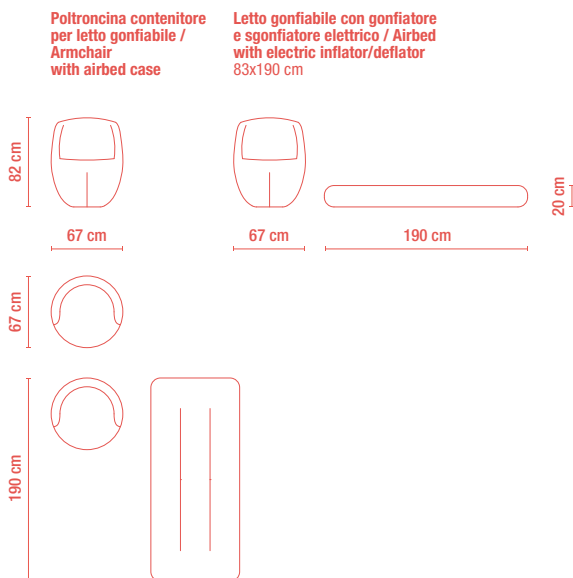

Profondità seduta / Seating depth 46 cm
Altezza seduta / Seat height 47 cm

Altezza materasso / Mattress height
20 cm (materasso in PVC gonfiabile / inflatable PVC mattress)

Pit

DESIGNER CAMPEGGI DESIGN

Struttura Inserto in legno rivestito in poliuretano espanso e fibra. **Meccanismo** Meccanismo del letto in acciaio, verniciatura a polveri epossidiche, meccanismo con apertura sincronizzata mediante ribaltamento della spalliera, supporto per dormire in maglia d'acciaio elettrosaldato. **Imbottitura** Poliuretano espanso senza CFC a quote differenziate e ovatta poliestere. **Piedino** Piedino in alluminio verniciato nero H 8 cm. **Materasso** Materasso in poliuretano espanso H 19 cm a una densità 25 kg/m³. **Sfoderabilità** Divano completamente sfoderabile.

Structure Wooden insert upholstered in polyurethane foam and fibre. **Bed mechanism** Steel bed mechanism with epoxy powder coating and synchronized opening system with backrest tilt; electro-welded steel mesh sleeping base. **Padding** CFC-free polyurethane foam with differentiated densities, covered with polyester wadding. **Feet** Black-painted aluminium feet, 8 cm high. **Mattress** Polyurethane foam mattress, 19 cm thick (density 25 kg/m³). **Removable covers** Fully removable upholstery.

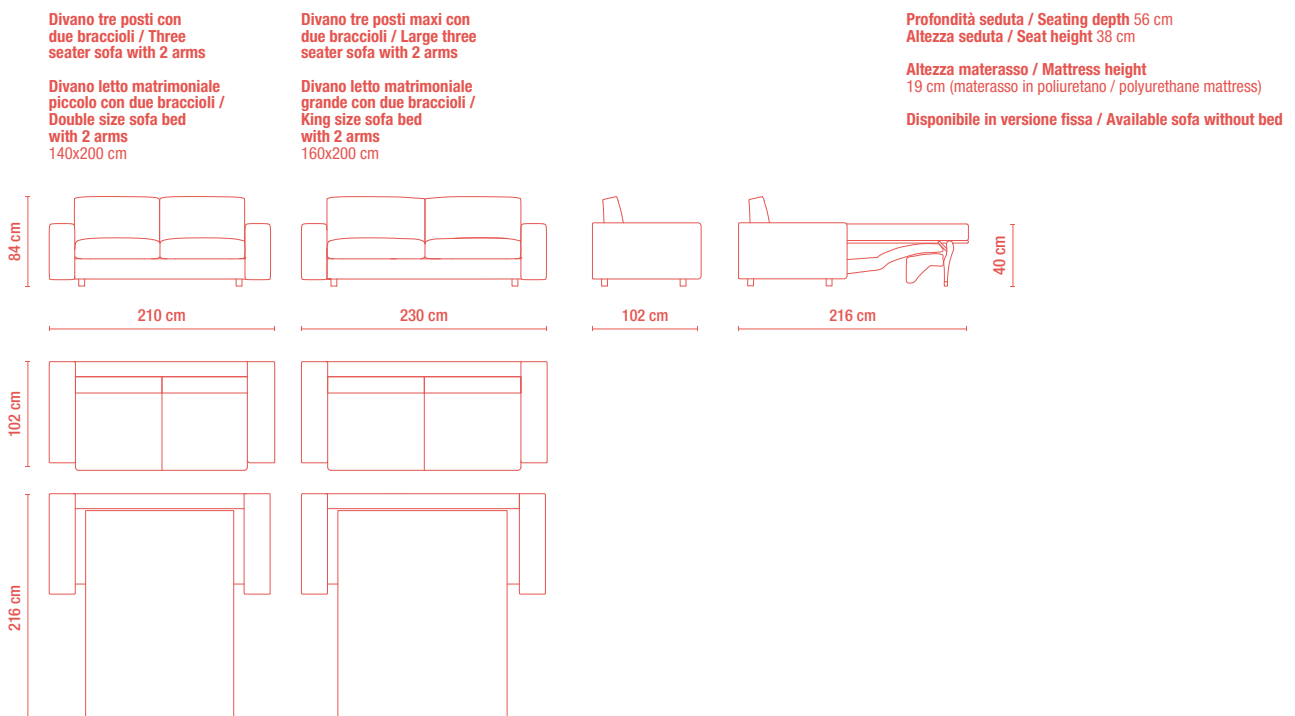

Divano tre posti con bracciolo sx/dx / Three seater sofa with 1 left/right arm

Divano letto matrimoniale piccolo con bracciolo sx/dx / Double size sofa bed with 1 left/right arm
140x200 cm

Divano tre posti maxi con bracciolo sx/dx / Large three seater sofa with 1 left/right arm

Divano letto matrimoniale grande con bracciolo sx/dx / King size sofa bed with 1 left/right arm
160x200 cm

Poltrona lunga con bracciolo sx/dx / Chaise longue with 1 left/right arm

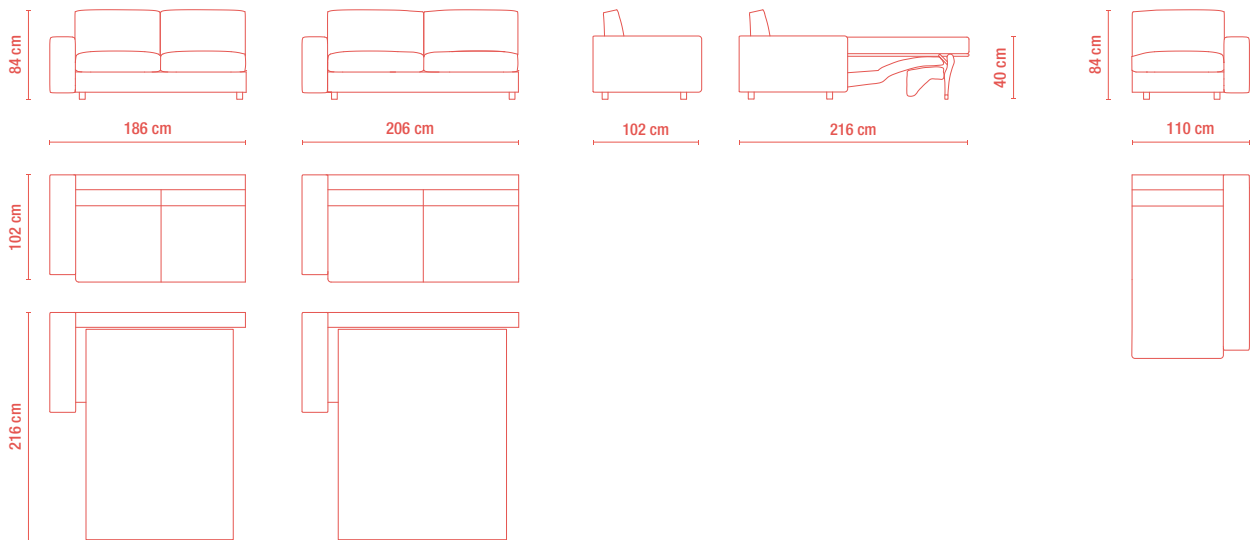

Plan

DESIGNER CAMPEGGI DESIGN

Struttura Inserto in legno rivestito in poliuretano espanso e fibra. **Meccanismo** Meccanismo del letto in acciaio, verniciatura a polveri epossidiche, meccanismo con apertura sincronizzata mediante ribaltamento della spalliera, supporto per dormire in doghe larghe in faggio stratificato anti affossamento. **Imbottitura** Poliuretano espanso senza CFC a quote differenziate e ovatta poliesteri. **Piedino** Piedino a slitta in alluminio lucido. **Materassi** Materasso in poliuretano espanso H 12 cm a una densità 25 kg/m³; Materasso a molle H 12 cm con rinforzo in poliuretano sul lato superiore. **Sfoderabilità** Divano completamente sfoderabile.

Structure Wooden insert upholstered in polyurethane foam and fibre. **Bed mechanism** Steel bed mechanism with epoxy powder coating and synchronized opening system with backrest tilt; laminated beech wide slats anti-sag sleeping base. **Padding** CFC-free polyurethane foam with differentiated densities, covered with polyester wadding. **Feet** Polished finished aluminium sled feet. **Mattresses** Polyurethane foam mattress, 12 cm thick (density 25 kg/m³); Spring mattress, 12 cm thick, with polyurethane reinforcement on the top side. **Removable covers** Fully removable upholstery.

Divano tre posti / Three seater sofa

Divano letto matrimoniale piccolo / Double size sofa bed
140x195 cm

Divano tre posti maxi / Large three seater sofa

Divano letto matrimoniale grande / King size sofa bed
160x195 cm

Profondità seduta / Seating depth 60 cm

Altezza seduta / Seat height 50 cm

Altezza materasso / Mattress height

12 cm (materasso a molle / spring mattress)

12 cm (materasso in poliuretano / polyurethane mattress)

Disponibile in versione fissa / Available sofa without bed

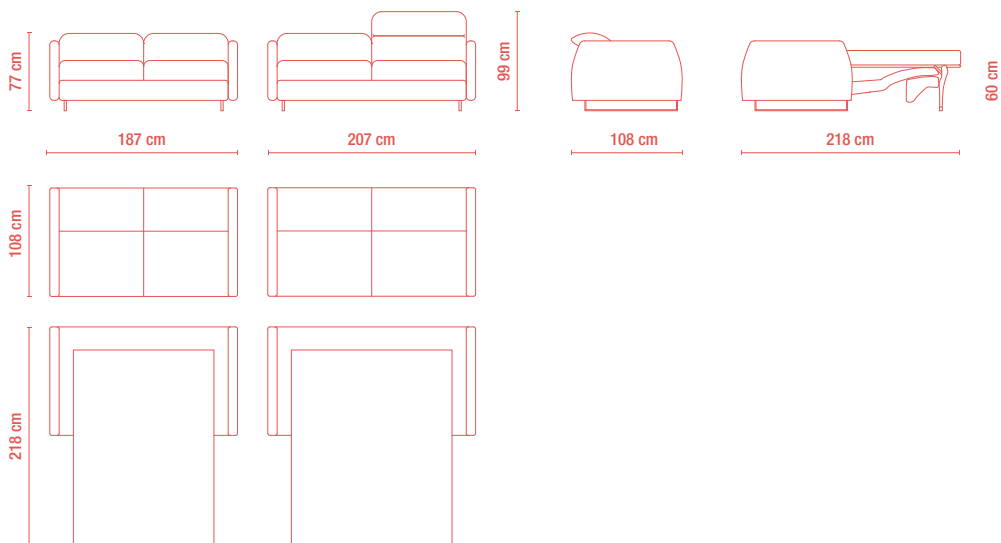

Q.letto

DESIGNER DENIS SANTACHIARA

Struttura Poliuretano espanso, rivestito in fibra poliestere e lycra. **Materassino** Materassino gonfiabile in PVC con pompa integrata H 20 cm, tecnologia in fibertech, peso massimo supportato 120 kg. Tempo di gonfiaggio 3 min circa. **Sfoderabilità** Materasso completamente sfoderabile.

Structure Polyurethane foam upholstered in polyester fibre and Lycra. **Mattress pad** Inflatable PVC mattress pad with integrated pump, 20 cm high, FiberTech™ technology, maximum supported weight 120 kg, approx. 3-minute inflation time. **Removable covers** Mattress pad fully removable.

Cuscino contenitore per letto gonfiabile con gonfiatore e sgonfiatore elettrico / Airbed suitcase with electric inflator/deflator 78x190 cm

Altezza materasso / Mattress height 20 cm (materasso in PVC gonfiabile / inflatable PVC mattress)

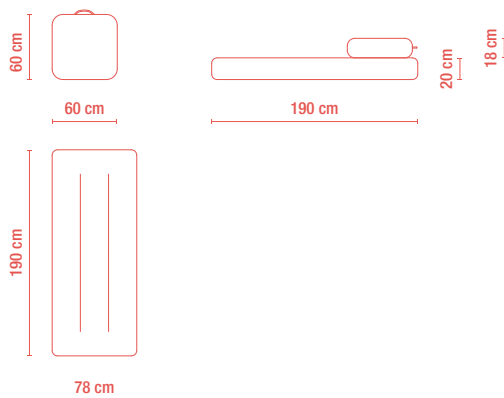

Quilt

DESIGNER GIULIO MANZONI

Struttura Inserto in legno rivestito in poliuretano espanso e fibra. **Meccanismo** Meccanismo del letto in acciaio, verniciatura a polveri epossidiche, meccanismo con apertura sincronizzata mediante ribaltamento della spalliera, supporto per dormire in maglia d'acciaio elettrosaldata. **Imbottitura** Poliuretano espanso senza CFC a quote differenziate e ovatta poliestere. **Materasso** Materasso in poliuretano espanso H 16 cm a una densità 25 kg/m³. **Sfoderabilità** Divano completamente sfoderabile.

Structure Wooden insert upholstered in polyurethane foam and fibre. **Bed mechanism** Steel bed mechanism with epoxy powder coating and synchronized opening system with backrest tilt; electro-welded steel mesh sleeping base. **Padding** CFC-free polyurethane foam with differentiated densities, covered with polyester wadding. **Mattress** Polyurethane foam mattress, 16 cm thick (density 25 kg/m³). **Removable covers** Fully removable upholstery.

Divano letto matrimoniale piccolo / Double size sofa bed 140x200 cm

Divano letto matrimoniale grande / King size sofa bed 160x200 cm

Profondità seduta / Seating depth 63 cm
Altezza seduta / Seat height 50 cm

Altezza materasso / Mattress height 16 cm (materasso in poliuretano / polyurethane mattress)

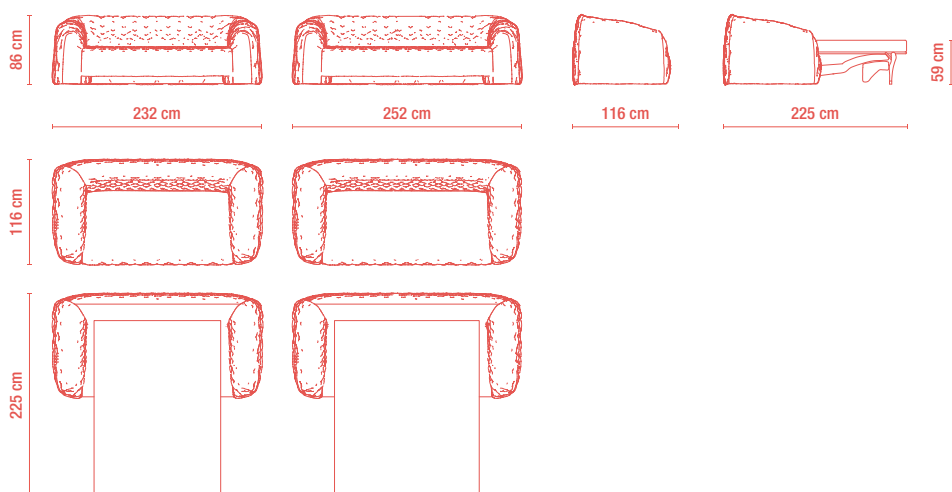

Struttura Inserto in legno rivestito in poliuretano espanso e fibra. **Meccanismo** Meccanismo del letto in acciaio, verniciatura a polveri epossidiche, meccanismo con apertura sincronizzata mediante ribaltamento della spalliera, supporto per dormire in maglia d'acciaio elettrosaldata. **Imbottitura** Poliuretano espanso senza CFC a quote differenziate e ovatta poliestere. **Piedino** Piedino in resina H 8 cm. **Profilo** Profilo perimetrale in alluminio satinato o più colorazioni. **Materasso** Materasso in poliuretano espanso H 16 cm a una densità 25 kg/m³. **Sfoderabilità** Divano completamente sfoderabile.

Structure Wooden insert upholstered in polyurethane foam and fibre. **Bed mechanism** Steel bed mechanism with epoxy powder coating and synchronized opening system with backrest tilt; electro-welded steel mesh sleeping base. **Padding** CFC-free polyurethane foam with differentiated densities, covered with polyester wadding. **Feet** Resin feet, 8 cm high. **Profile** Satin-finished aluminium perimeter profile, available in multiple colours. **Mattress** Polyurethane foam mattress, 16 cm thick (density 25 kg/m³). **Removable covers** Fully removable upholstery.

Divano due posti con due braccioli / Two seater sofa with 2 arms

Divano tre posti con due braccioli / Three seater sofa with 2 arms

Divano tre posti maxi con due braccioli / Large three seater sofa with 2 arms

Divano letto piazza e mezza con due braccioli / Small double size sofa bed with 2 arms
120x195 cm

Divano letto matrimoniale piccolo con due braccioli / Double size sofa bed with 2 arms
140x195 cm

Divano letto matrimoniale grande con due braccioli / King size sofa bed with 2 arms
160x195 cm

Profondità seduta / Seating depth 70 cm
Altezza seduta / Seat height 44 cm

Altezza materasso / Mattress height 16 cm (materasso in poliuretano / polyurethane mattress)

Disponibile in versione fissa / Available sofa without bed

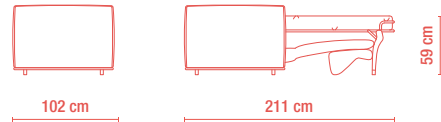
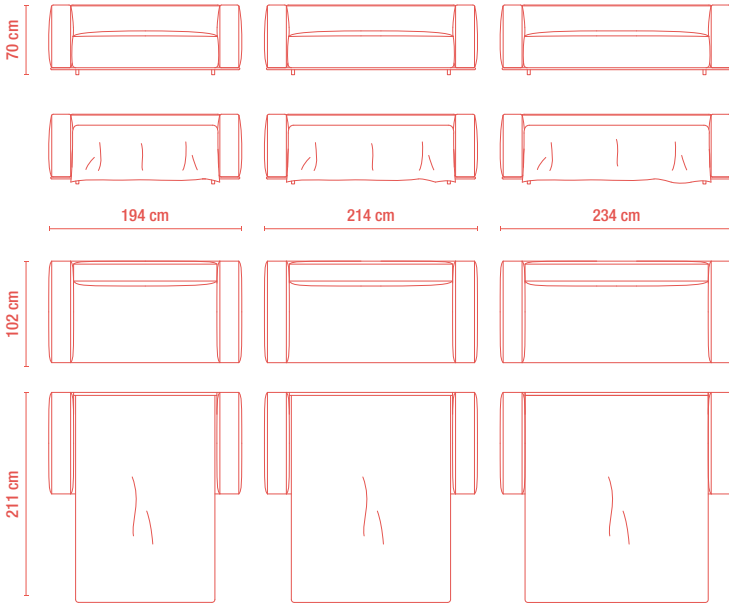

Divano due posti con bracciolo sx/dx / Two seater sofa with 1 left/right arm

Divano tre posti con bracciolo sx/dx / Three seater sofa with 1 left/right arm

Divano tre posti maxi con bracciolo sx/dx / Large three seater sofa with 1 left/right arm

Divano letto piazza e mezza con bracciolo sx/dx / Small double size sofa bed with 1 left/right arm
120x195 cm

Divano letto matrimoniale piccolo con bracciolo sx/dx / Double size sofa bed with 1 left/right arm
140x195 cm

Divano letto matrimoniale grande con bracciolo sx/dx / King size sofa bed with 1 left/right arm
160x195 cm

Poltrona lunga con bracciolo sx/dx / Chaise longue with 1 left/right arm

*Solo in accostamento a divano con un bracciolo / Only combined with a sofa/sofa bed with 1 arm

*Solo in accostamento a poltrona lunga / Only combined with a chaise longue

*Solo in accostamento a poltrona lunga / Only combined with a chaise longue

*Solo in accostamento a poltrona lunga / Only combined with a chaise longue

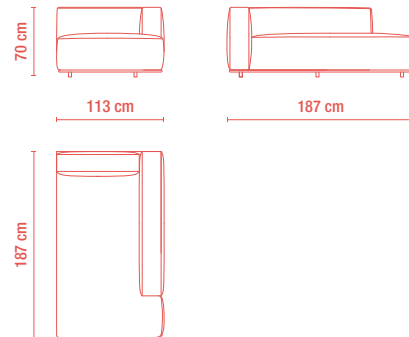
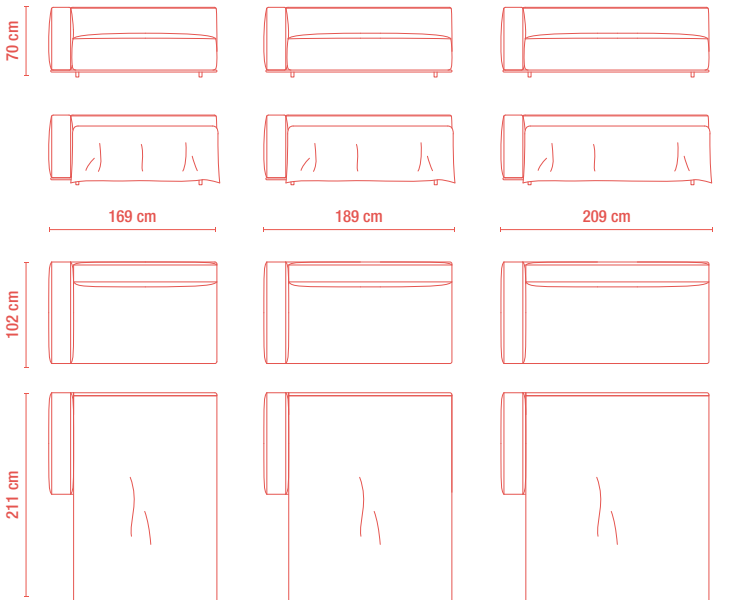

Struttura Inserto in legno rivestito in poliuretano espanso e fibra. **Meccanismo** Meccanismo del letto in acciaio, verniciatura a polveri epossidiche, meccanismo con apertura sincronizzata mediante ribaltamento della spalliera, supporto per dormire in maglia d'acciaio elettrosaldata. **Imbottitura** Poliuretano espanso senza CFC a quote differenziate e ovatta poliestere. **Materasso** Materasso in poliuretano espanso H 16 cm a una densità 25 kg/m³. **Sfoderabilità** Divano completamente sfoderabile.

Structure Wooden insert upholstered in polyurethane foam and fibre. **Bed mechanism** Steel bed mechanism with epoxy powder coating and synchronized opening system with backrest tilt; electro-welded steel mesh sleeping base. **Padding** CFC-free polyurethane foam with differentiated densities, covered with polyester wadding. **Mattress** Polyurethane foam mattress, 16 cm thick (density 25 kg/m³). **Removable covers** Fully removable upholstery.

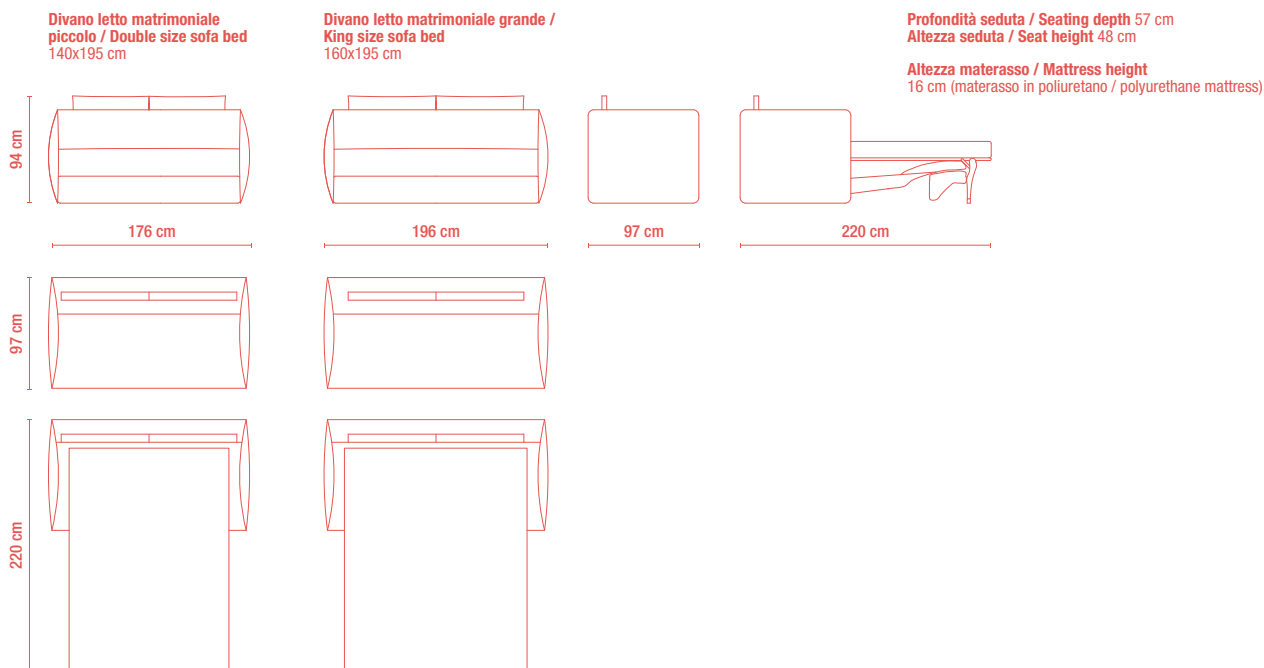

Struttura Struttura in acciaio verniciato verde e struttura in tessuto sintetico color bianco.

Structure Green-painted steel frame with white synthetic fabric structure.

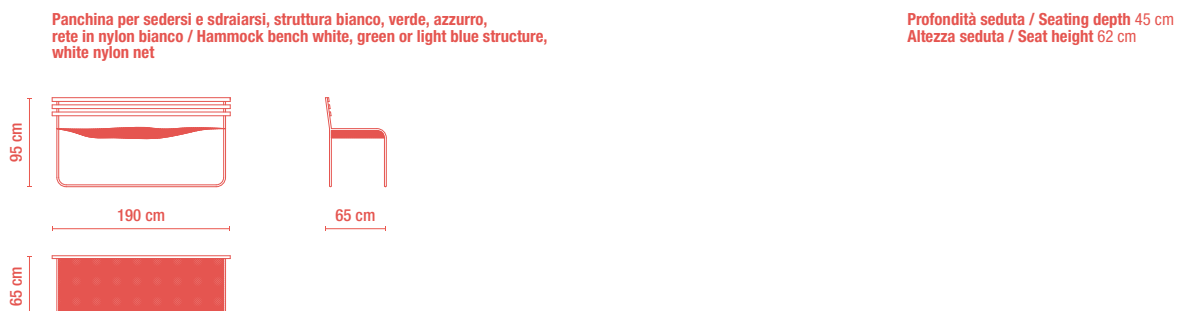

Struttura Inserto in legno rivestito in poliuretano espanso e fibra. **Meccanismo** Meccanismo del letto in acciaio, verniciatura a polveri epossidiche, meccanismo ad estrazione dotato di sistema di sollevamento semiautomatico mediante maniglia, supporto per dormire in doghe larghe in faggio stratificato anti affossamento. **Imbottitura** Poliuretano espanso senza CFC a quote differenziate e ovatta poliestere. **Materasso** Materasso in poliuretano espanso H 14 cm a una densità 25 kg/m³; Materasso a molle H 14 cm con rinforzo in poliuretano sul lato superiore. **Sfoderabilità** Divano completamente sfoderabile.

Structure Wooden insert upholstered in polyurethane foam and fibre. **Bed mechanism** Steel bed mechanism with epoxy powder coating and pull-out system featuring a semi-automatic lifting mechanism operated by handle; laminated beech wide slats anti-sag sleeping base. **Padding** CFC-free polyurethane foam with differentiated densities, covered with polyester wadding. **Mattress** Polyurethane foam mattress, 14 cm thick (density 25 kg/m³); Spring mattress, 14 cm thick, with polyurethane reinforcement on the top side. **Removable covers** Fully removable upholstery.

SKY UNO

Divano letto singolo con due braccioli larghi / Small single sofa bed with 2 large arms
75x187 cm

Divano letto singolo e secondo letto con due braccioli larghi / Small single sofa bed with twin bed with 2 large arms
75x187 cm
150x187 cm

Divano letto singolo e portaoggetti con due braccioli larghi / Small single sofa bed with glove compartment with 2 large arms
75x187 cm

Profondità seduta / Seating depth 55 cm
Altezza seduta / Seat height 48 cm

Altezza materasso / Mattress height
14 cm (materasso a molle / spring mattress)
14 cm (materasso in poliuretano / polyurethane mattress)

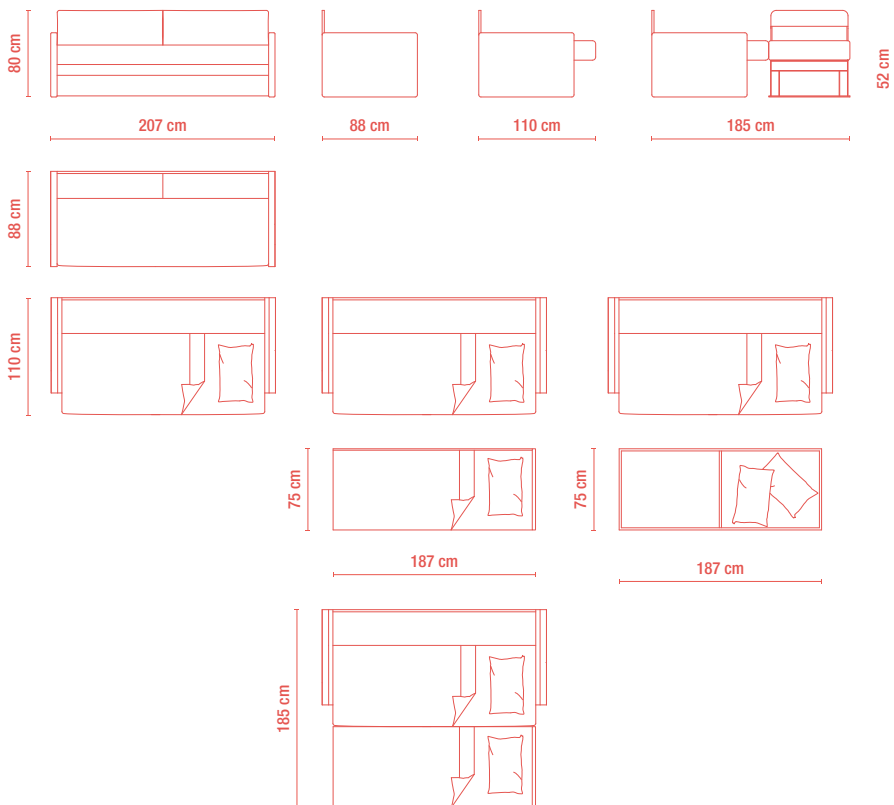

SKY DUE

Divano letto singolo e secondo letto con due braccioli stretti / Small single sofa bed with twin bed with 2 small arms
 75x187 cm
 150x187 cm

Divano letto singolo e portaoggetti con due braccioli stretti / Small single sofa bed with glove compartment with 2 small arms
 75x187 cm

Profondità seduta / Seating depth 55 cm
Altezza seduta / Seat height 48 cm

Altezza materasso / Mattress height
 14 cm (materasso a molle / spring mattress)
 14 cm (materasso in poliuretano / polyurethane mattress)

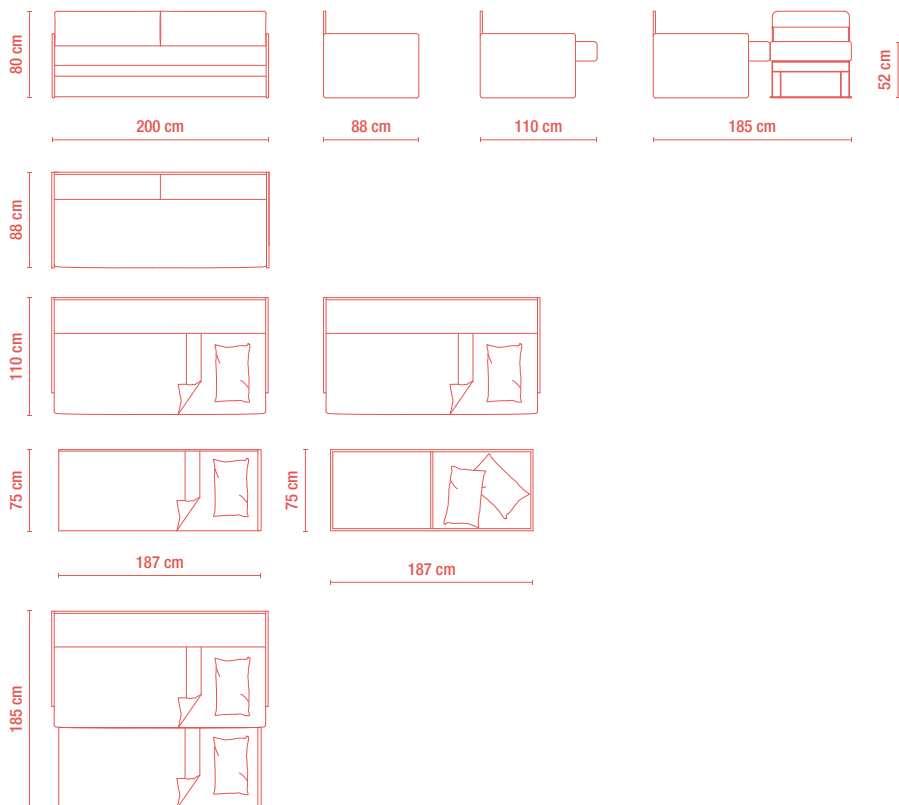

SKYTRE

Divano letto singolo e secondo letto con due braccioli alti / Small single sofa bed with twin bed and 2 high arms
75x187 cm
150x187 cm

Divano letto singolo e portaoggetti con due braccioli alti / Small single sofa bed with glove compartment and 2 high arms
75x187 cm

Altezza seduta / Seat height 48 cm

Altezza materasso / Mattress height
14 cm (materasso a molle / spring mattress)
14 cm (materasso in poliuretano / polyurethane mattress)

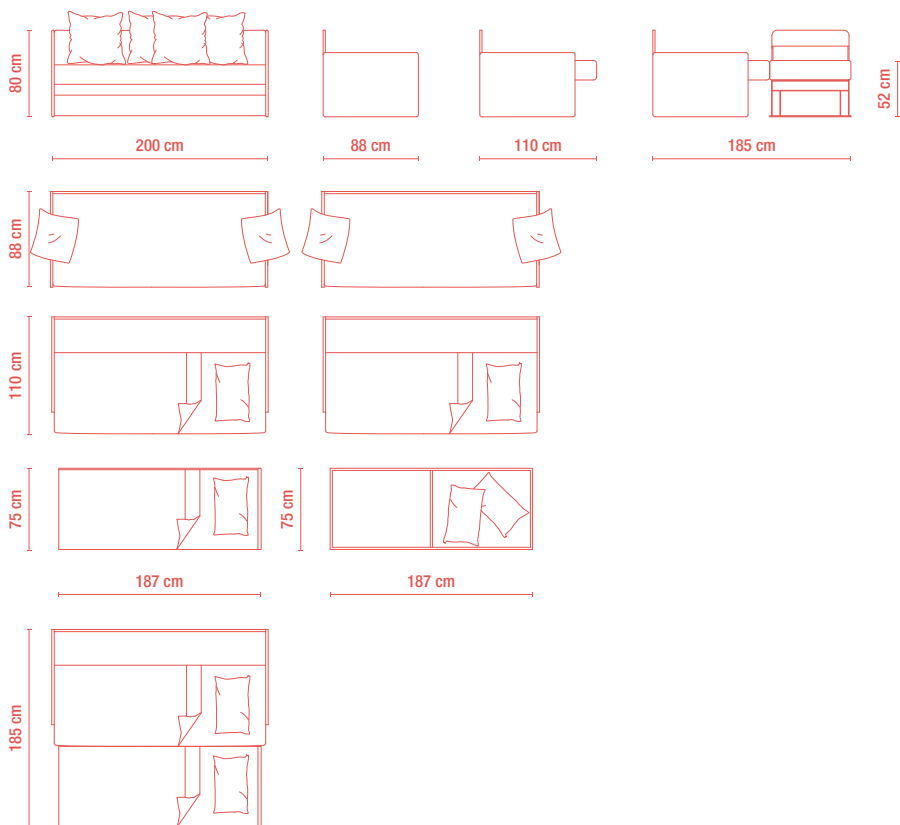

Divano letto singolo e secondo letto con bracciolo alto sx/dx / Small single sofa bed with twin bed and 1 high left/right arm
75x187 cm
150x187 cm

Divano letto singolo e portaoggetti con bracciolo alto sx/dx / Small single sofa bed with glove compartment and 1 high left/right arm
75x187 cm

Divano letto singolo e secondo letto senza braccioli alti / Small single sofa bed with twin bed without arms
75x187 cm
150x187 cm

Divano letto singolo e portaoggetti senza braccioli alti / Small single sofa bed with glove compartment without arms
75x187 cm



Struttura Inserto in legno rivestito in poliuretano espanso e fibra. **Meccanismo** Meccanismo del letto in acciaio, verniciatura a polveri epossidiche, meccanismo con apertura sincronizzata mediante ribaltamento della spalliera, supporto per dormire in maglia d'acciaio elettrosaldata. **Imbottitura** Poliuretano espanso senza CFC a quote differenziate e ovatta poliestere. **Materasso** Materasso in poliuretano espanso H 19 cm a una densità 25 kg/m³. **Sfoderabilità** Divano completamente sfoderabile.

Structure Wooden insert upholstered in polyurethane foam and fibre. **Bed mechanism** Steel bed mechanism with epoxy powder coating and synchronized opening system with backrest tilt; electro-welded steel mesh sleeping base. **Padding** CFC-free polyurethane foam with differentiated densities, covered with polyester wadding. **Mattress** Polyurethane foam mattress, 19 cm thick (density 25 kg/m³). **Removable covers** Fully removable upholstery.

SNOB – LARGHEZZA BRACCIOLO / ARMREST WIDTH 20 cm

Divano letto matrimoniale piccolo /
Double size sofa bed
140x195 cm

Divano letto matrimoniale grande /
King size sofa bed
160x195 cm

Profondità seduta / Seating depth 60 cm
Altezza seduta / Seat height 49 cm

Altezza materasso / Mattress height
19 cm (materasso in poliuretano / polyurethane mattress)

Vano contenitore porta guanciaie / Pillow storage compartment

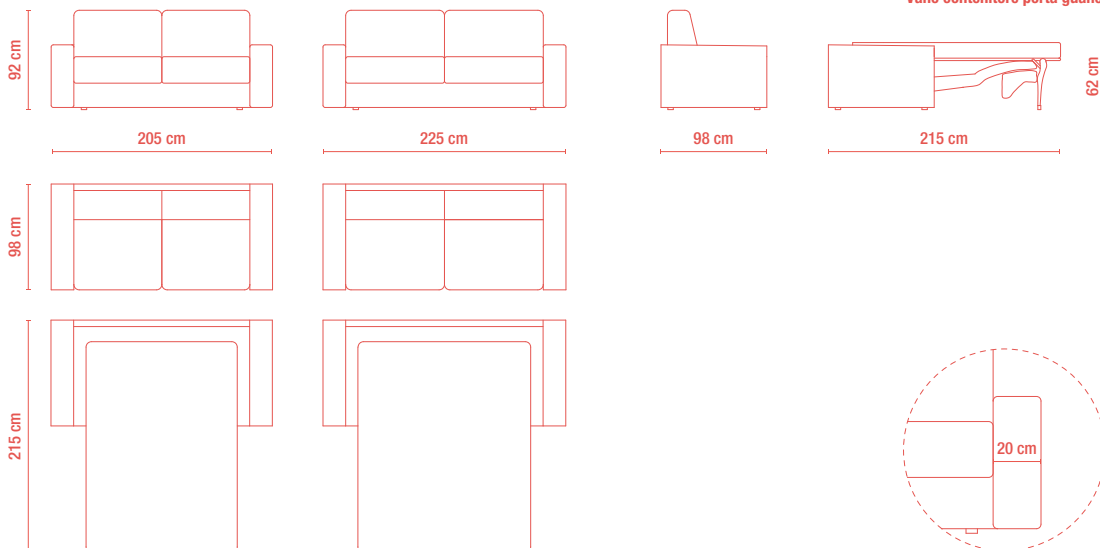

SNOB SMALL – LARGHEZZA BRACCIOLO / ARMREST WIDTH 10 cm

Divano letto matrimoniale piccolo /
Double size sofa bed
140x195 cm

Divano letto matrimoniale grande /
King size sofa bed
160x195 cm

Profondità seduta / Seating depth 60 cm
Altezza seduta / Seat height 49 cm

Altezza materasso / Mattress height
19 cm (materasso in poliuretano / polyurethane mattress)

Vano contenitore porta guanciaie / Pillow storage compartment

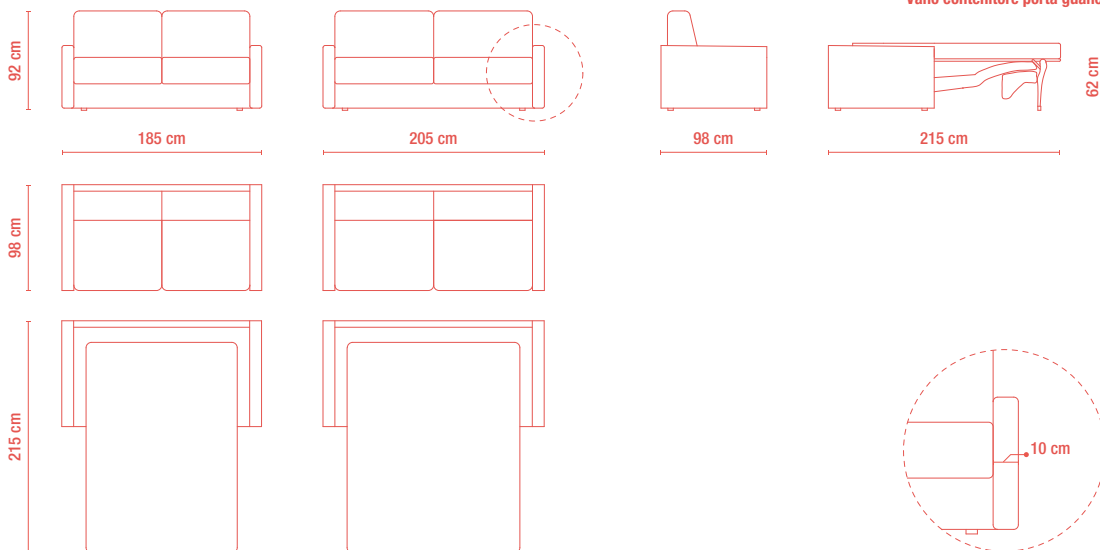

Struttura Inserto in legno rivestito in poliuretano espanso e fibra. **Meccanismo** Meccanismo del letto in acciaio, verniciatura a polveri epossidiche, meccanismo con apertura sincronizzata mediante ribaltamento della spalliera, supporto per dormire in maglia d'acciaio elettrosaldata. **Imbottitura** Poliuretano espanso senza CFC a quote differenziate e ovatta poliestere. **Materassi** Materasso in poliuretano espanso H 12 cm a una densità 25 kg/m³. **Sfoderabilità** Divano completamente sfoderabile.

Structure Wooden insert upholstered in polyurethane foam and fibre. **Bed mechanism** Steel bed mechanism with epoxy powder coating and synchronized opening system with backrest tilt; electro-welded steel mesh sleeping base. **Padding** CFC-free polyurethane foam with differentiated densities, covered with polyester wadding. **Mattress** Polyurethane foam mattress, 12 cm thick (density 25 kg/m³). **Removable covers** Fully removable upholstery.

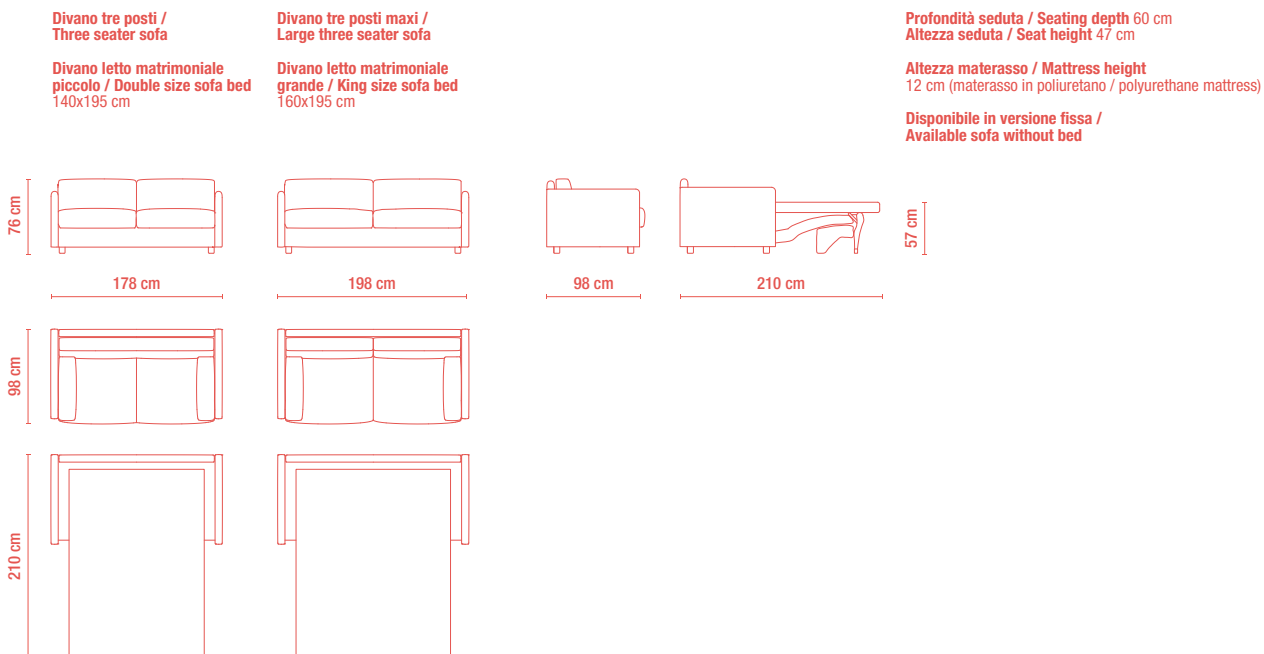

Tango

Struttura Inserto in legno rivestito in poliuretano espanso e fibra. **Meccanismo** Meccanismo del letto in acciaio, verniciatura a polveri epossidiche, meccanismo con apertura sincronizzata mediante ribaltamento della spalliera, supporto per dormire in maglia d'acciaio elettrosaldata. **Imbottitura** Poliuretano espanso senza CFC a quote differenziate e ovatta poliestere. **Materasso** Materasso in poliuretano espanso H 16 cm a una densità 25 kg/m³. **Sfoderabilità** Divano completamente sfoderabile.

Structure Wooden insert upholstered in polyurethane foam and fibre. **Bed mechanism** Steel bed mechanism with epoxy powder coating and synchronized opening system with backrest tilt; electro-welded steel mesh sleeping base. **Padding** CFC-free polyurethane foam with differentiated densities, covered with polyester wadding. **Mattress** Polyurethane foam mattress, 16 cm thick (density 25 kg/m³). **Removable covers** Fully removable upholstery.

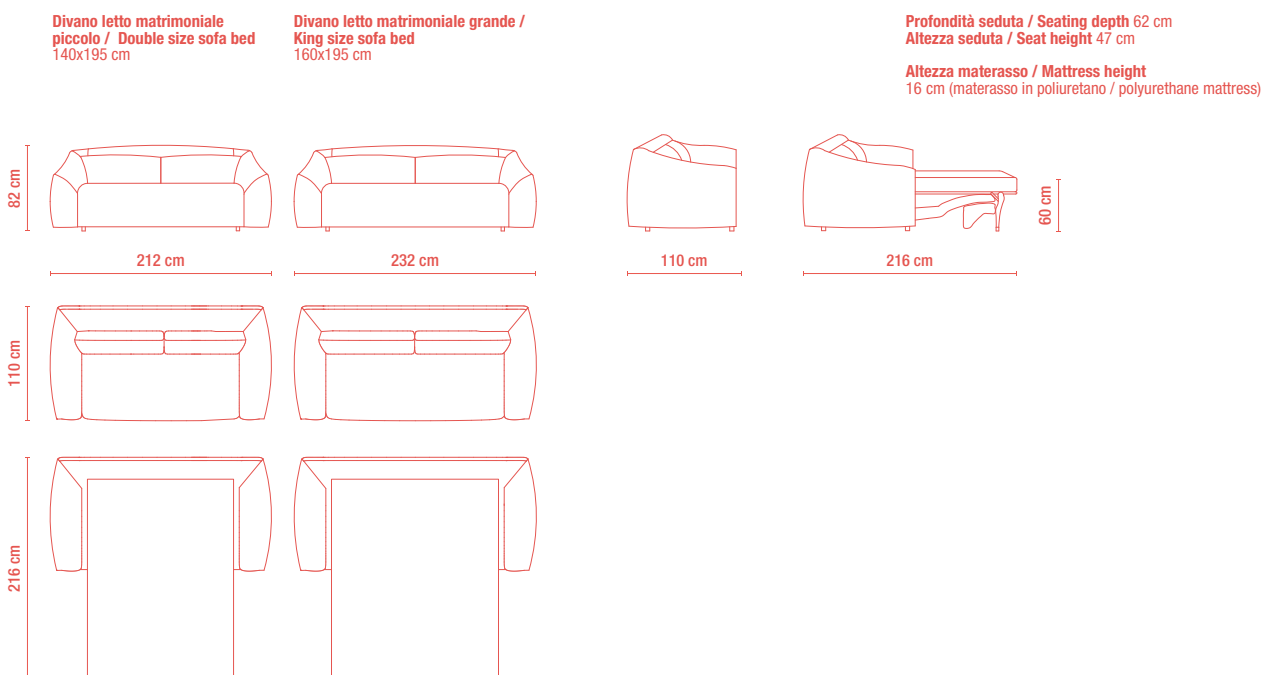

Tip-Tap

DESIGNER GIULIO MANZONI

Struttura Inserto in legno rivestito in poliuretano espanso e fibra. **Meccanismo** Meccanismo del letto in acciaio, verniciatura a polveri epossidiche, meccanismo con apertura sincronizzata mediante ribaltamento della spalliera, supporto per dormire in maglia d'acciaio elettrosaldata. **Imbottitura** Poliuretano espanso senza CFC a quote differenziate e ovatta poliestere. **Piedino** Piedino in alluminio lucido H 8 cm. **Materasso** Materasso in poliuretano espanso H 16 cm a una densità 25 kg/m³. **Sfoderabilità** Divano completamente sfoderabile.

Structure Wooden insert upholstered in polyurethane foam and fibre. **Bed mechanism** Steel bed mechanism with epoxy powder coating and synchronized opening system with backrest tilt; electro-welded steel mesh sleeping base. **Padding** CFC-free polyurethane foam with differentiated densities, covered with polyester wadding. **Feet** Polished aluminium feet, 8 cm high. **Mattress** Polyurethane foam mattress, 16 cm thick (density 25 kg/m³). **Removable covers** Fully removable upholstery.

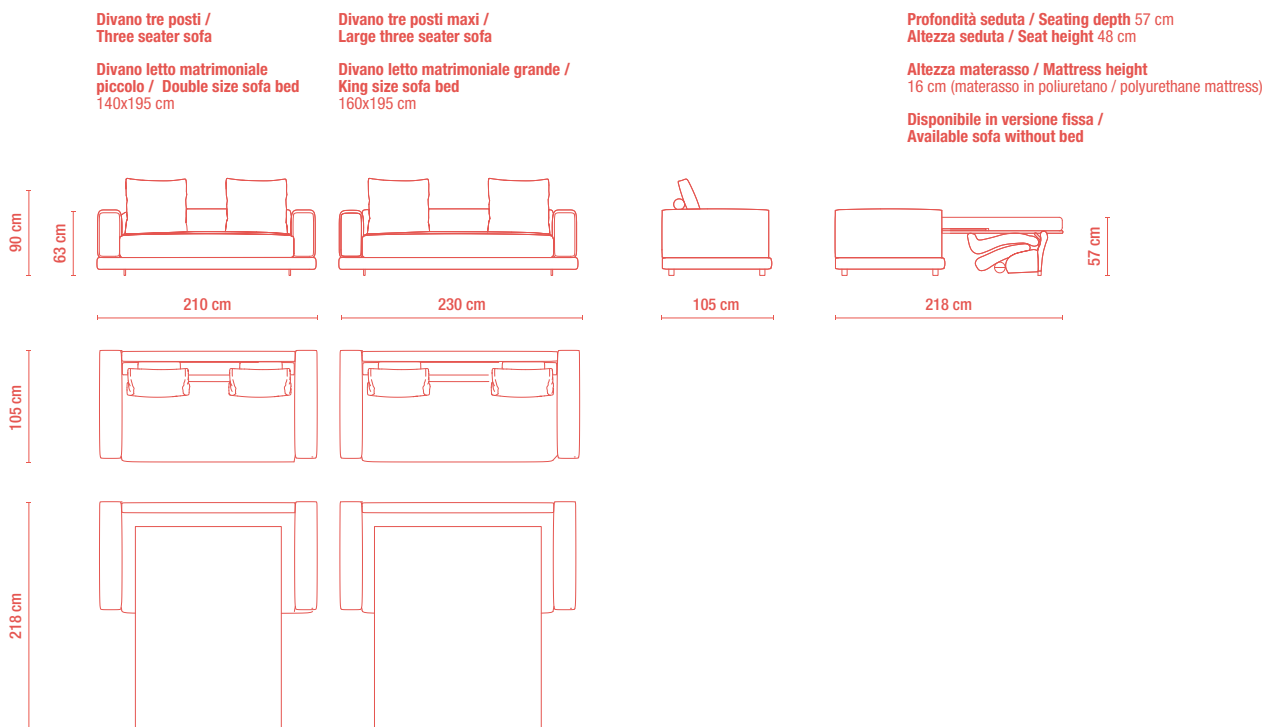

Tutù

DESIGNER CAMPEGGI DESIGN

Struttura Struttura in acciaio rivestita in poliuretano espanso e fibra. **Mecanismo** Meccanismo del letto in acciaio, verniciatura a polveri epossidiche, meccanismo con apertura a libro mediante rialzo del piano di seduta, supporto per dormire in maglia d'acciaio elettrosaldata. **Imbottitura** Poliuretano espanso senza CFC a quote differenziate e ovatta poliestere. **Materasso** Materasso in poliuretano espanso H 11 cm a una densità 25 kg/m³. **Sfoderabilità** Poltrona completamente sfoderabile.

Structure Steel frame upholstered in polyurethane foam and fibre. **Bed mechanism** Steel bed mechanism with epoxy powder coating and book-style opening system via seat platform lift; electro-welded steel mesh sleeping base. **Padding** CFC-free polyurethane foam with differentiated densities, covered with polyester wadding. **Mattress** Polyurethane foam mattress, 11 cm thick (density 25 kg/m³). **Removable covers** Fully removable upholstery.

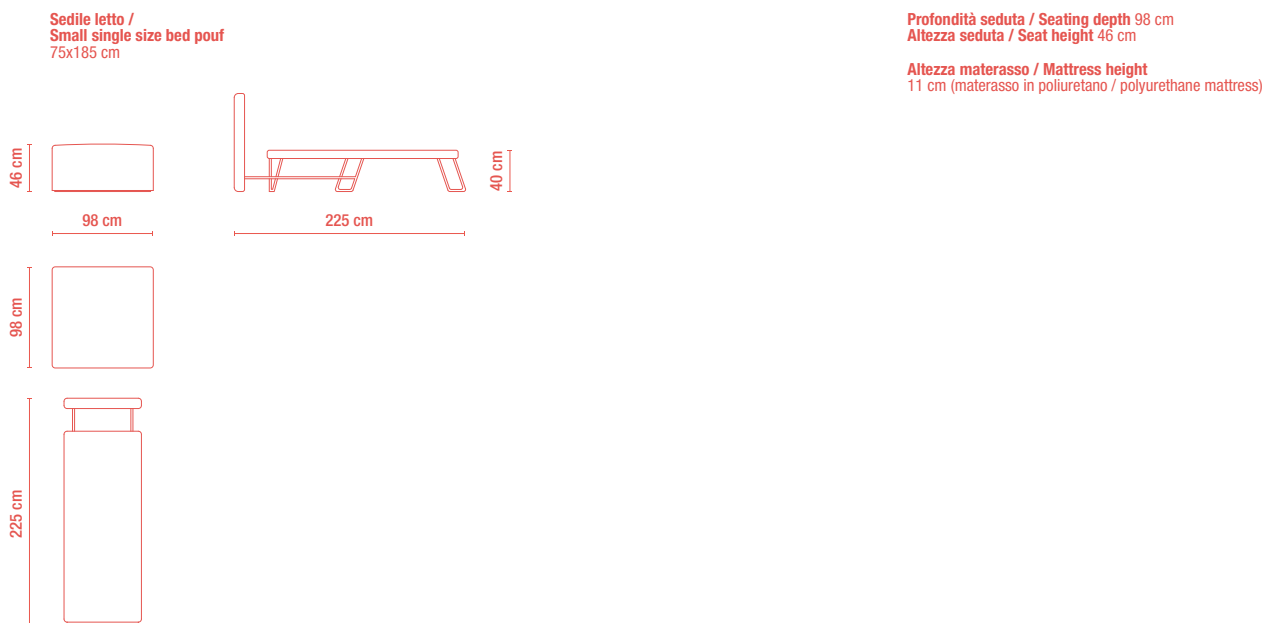

Underdog

DESIGNER LORENZO DAMIANI

Struttura Struttura in acciaio verniciata nero su ruote. **Mecanismo** Meccanismo del letto in acciaio, verniciatura a polveri epossidiche, meccanismo con apertura a libro, supporto per dormire in cinghie elastiche. **Imbottitura** Poliuretano espanso senza CFC a quote differenziate e ovatta poliestere. **Materasso** Materasso in poliuretano espanso H 11 cm a una densità 25 kg/m³. **Sfoderabilità** Completamente sfoderabile.

Structure Black-painted steel frame on castors. **Bed mechanism** Steel bed mechanism with epoxy powder coating and book-style opening system; elastic webbing sleeping base. **Padding** CFC-free polyurethane foam with differentiated densities, covered with polyester wadding. **Mattress** Polyurethane foam mattress, 11 cm thick (density 25 kg/m³). **Removable covers** Fully removable upholstery.

Letto nomade e seduta non convenzionale /
Nomadic bed and unconventional seat
78x193 cm

Altezza seduta / Seat height 57 cm

Altezza materasso / Mattress height
11 cm (materasso in poliuretano / polyurethane mattress)

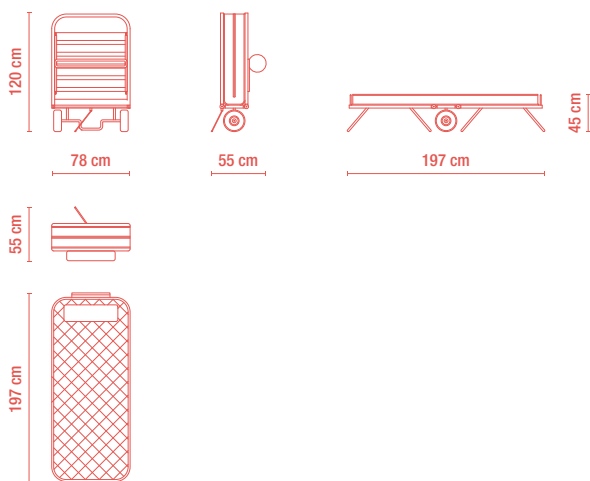

Virgola

DESIGNER GIULIO MANZONI

Struttura Struttura in acciaio rivestita in poliuretano espanso e fibra. **Mecanismo** Meccanismo del letto in acciaio, verniciatura a polveri epossidiche, meccanismo con apertura frontale a piani sovrapposti, supporto per dormire in maglia d'acciaio elettrosaldata. **Imbottitura** Poliuretano espanso senza CFC a quote differenziate e ovatta poliestere. **Materasso** Materasso in poliuretano espanso H 10 cm a una densità 25 kg/m³. **Sfoderabilità** Poltrona completamente sfoderabile.

Structure Steel frame upholstered in polyurethane foam and fibre. **Bed mechanism** Steel bed mechanism with epoxy powder coating and front-opening mechanism with overlapping panels; electro-welded steel mesh sleeping base. **Padding** CFC-free polyurethane foam with differentiated densities, covered with polyester wadding. **Mattress** Polyurethane foam mattress, 10 cm thick (density 25 kg/m³). **Removable covers** Fully removable upholstery.

Poltrona letto con bracciolo sx/dx /
Small single size chair bed with 1 left/right arm
68x202 cm

Profondità seduta / Seating depth 68 cm

Altezza seduta / Seat height 45 cm

Altezza materasso / Mattress height
10 cm (materasso in poliuretano / polyurethane mattress)

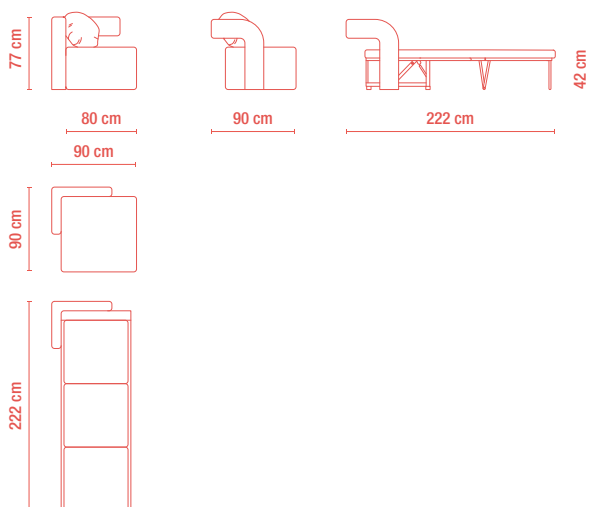

Struttura Struttura in acciaio rivestita in tessuto e fibra poliestere. **Meccanismo** Meccanismo del letto in acciaio, verniciatura a polveri epossidiche, meccanismo con apertura frontale a piani sovrapposti, supporto per dormire in maglia d'acciaio elettrosaldata. **Imbottitura** Poliuretano espanso senza CFC a quote differenziate e ovatta poliestere. **Materasso** Materasso in poliuretano espanso H 10 cm a una densità 25 kg/m³. **Sfoderabilità** Poltrona completamente sfoderabile.

Structure Steel frame upholstered in polyurethane foam and fibre. **Bed mechanism** Steel bed mechanism with epoxy powder coating and front-opening mechanism with overlapping panels; electro-welded steel mesh sleeping base. **Padding** CFC-free polyurethane foam with differentiated densities, covered with polyester wadding. **Mattress** Polyurethane foam mattress, 10 cm thick (density 25 kg/m³). **Removable covers** Fully removable upholstery.

Pouf letto / Single bed pouf
75x198 cm

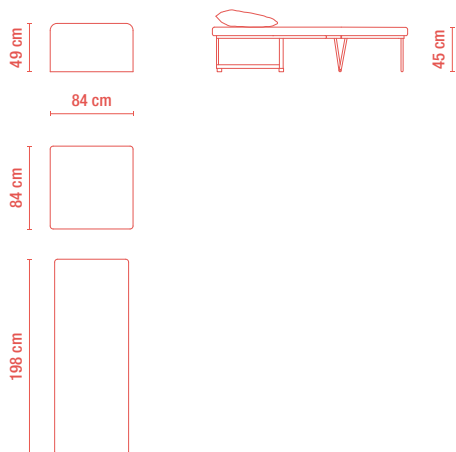

Profondità seduta / Seating depth 84 cm
Altezza seduta / Seat height 49 cm

Altezza materasso / Mattress height
10 cm (materasso in poliuretano / polyurethane mattress)

Struttura Inserto in legno rivestito in poliuretano espanso e fibra. **Meccanismo** Meccanismo del letto in acciaio, verniciatura a polveri epossidiche, meccanismo con apertura sincronizzata mediante ribaltamento della spalliera, supporto per dormire in maglia d'acciaio elettrosaldata. **Imbottitura** Poliuretano espanso senza CFC a quote differenziate e ovatta poliestere. **Materasso** Materasso in poliuretano espanso H 12 cm a una densità 25 kg/m³. **Sfoderabilità** Divano completamente sfoderabile.

Structure Wooden insert upholstered in polyurethane foam and fibre. **Bed mechanism** Steel bed mechanism with epoxy powder coating and synchronized opening system with backrest tilt; electro-welded steel mesh sleeping base. **Padding** CFC-free polyurethane foam with differentiated densities, covered with polyester wadding. **Mattress** Polyurethane foam mattress, 12 cm thick (density 25 kg/m³). **Removable covers** Fully removable upholstery.

ZAZÀ – LARGHEZZA BRACCIOLO / ARMREST WIDTH 20 cm

<p>Poltrona maxi con due braccioli / Armchair maxi with 2 arms</p> <p>Poltrona letto con due braccioli / Chair bed with 2 arms 70x195 cm</p>	<p>Divano due posti con due braccioli / Two seater sofa with 2 arms</p> <p>Divano letto piazza e mezza con due braccioli / Small double size sofa bed with 2 arms 120x195 cm</p>	<p>Divano tre posti con due braccioli / Three seater sofa with 2 arms</p> <p>Divano letto matrimoniale piccolo con due braccioli / Double size sofa bed with 2 arms 140x195 cm</p>	<p>Divano tre posti maxi con due braccioli / Large three seater sofa with 2 arms</p> <p>Divano letto matrimoniale grande con due braccioli / King size sofa bed with 2 arms 160x195 cm</p>	<p>Profondità seduta / Seating depth 60 cm Altezza seduta / Seat height 45 cm</p> <p>Altezza materasso / Mattress height 12 cm (materasso in poliuretano / polyurethane mattress)</p> <p>Vano contenitore porta guanciaie / Pillow storage compartment</p> <p>Disponibile in versione fissa / Available sofa without bed</p>	
138 cm	188 cm	208 cm	228 cm	95 cm	210 cm
95 cm					57 cm
210 cm					

<p>Poltrona maxi con bracciolo sx/dx / Armchair maxi with 1 left/right arm</p> <p>Poltrona letto con bracciolo sx/dx / Chair bed with 1 left/right arm 70x195 cm</p>	<p>Divano due posti con bracciolo sx/dx / Two seater sofa with 1 left/right arm</p> <p>Divano letto piazza e mezza con bracciolo sx/dx / Small double size sofa bed with 1 left/right arm 120x195 cm</p>	<p>Divano tre posti con bracciolo sx/dx / Three seater sofa with 1 left/right arm</p> <p>Divano letto matrimoniale piccolo con bracciolo sx/dx / Double size sofa bed with 1 left/right arm 140x195 cm</p>	<p>Divano tre posti maxi con bracciolo sx/dx / Large three seater sofa with 1 left/right arm</p> <p>Divano letto matrimoniale grande con bracciolo sx/dx / King size sofa bed with 1 left/right arm 160x195 cm</p>		
115 cm	165 cm	185 cm	205 cm	95 cm	210 cm
95 cm					57 cm
210 cm					



**Poltrona maxi
senza braccioli /
Armchair maxi
without arms**

**Poltrona letto
senza braccioli /
Chair bed
without arms
70x195 cm**

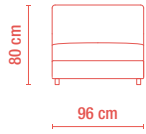

**Divano due posti
senza braccioli /
Two seater sofa
without arms**

**Divano letto piazza e mezza
senza braccioli /
Small double size sofa bed
without arms
120x195 cm**

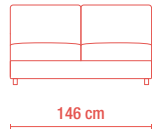

**Divano tre posti senza
braccioli / Three seater sofa
without arms**

**Divano letto matrimoniale
piccolo senza braccioli /
Double size sofa bed
without arms
140x195 cm**

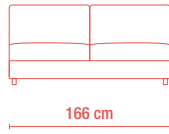

**Divano tre posti maxi
senza braccioli / Large three
seater sofa without arms**

**Divano letto matrimoniale
grande senza braccioli /
King size sofa bed
without arms
160x195 cm**

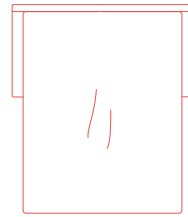
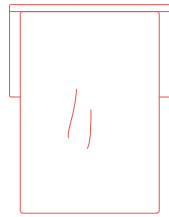
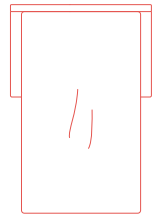
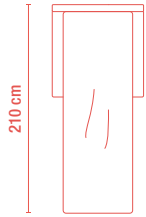
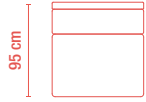
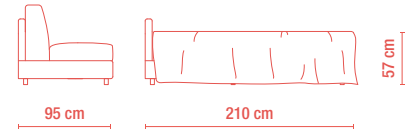
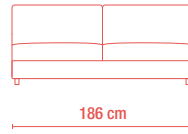

**Poltrona lunga stretta con due braccioli
senza contenitore / Narrow chaise longue
with 2 arms without glove compartment**

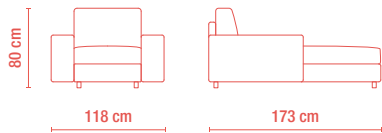

**Poltrona lunga stretta con bracciolo sx/dx
senza contenitore / Narrow chaise longue
with 1 left/right arm without glove compartment**

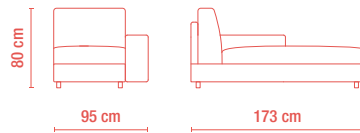

**Poltrona lunga stretta senza braccioli
senza contenitore / Narrow chaise longue
without arms without glove compartment**

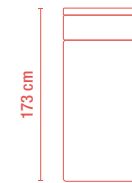
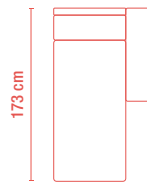
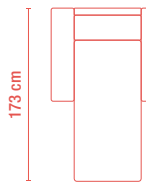
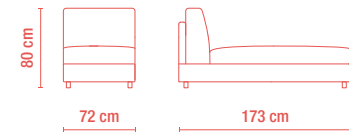

**Poltrona lunga larga con due braccioli
con contenitore / Large chaise longue
with 2 arms with glove compartment**

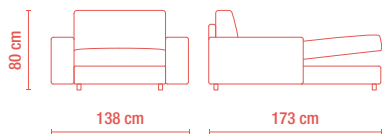

**Poltrona lunga larga con bracciolo sx/dx
con contenitore / Large chaise longue
with 1 left/right arm with glove compartment**

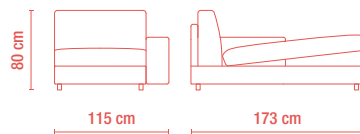

**Poltrona lunga larga senza braccioli
con contenitore / Large chaise longue
without arms with glove compartment**

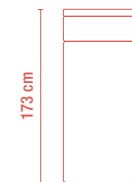
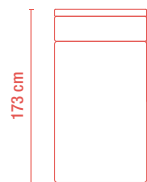
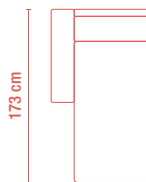
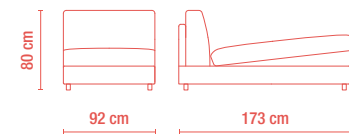

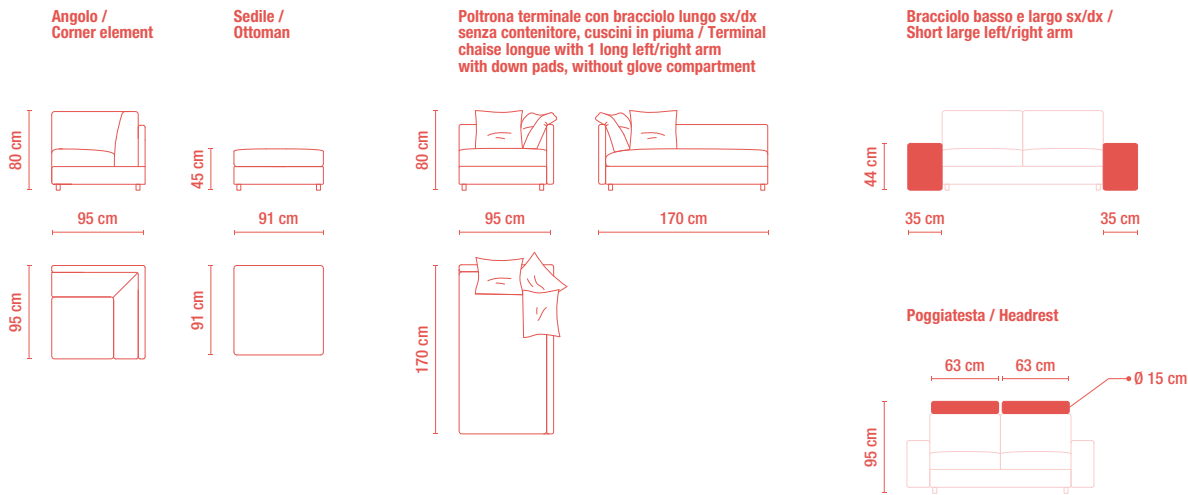

ZAZÀ SMALL – LARGHEZZA BRACCIOLO / ARMREST WIDTH 10 cm

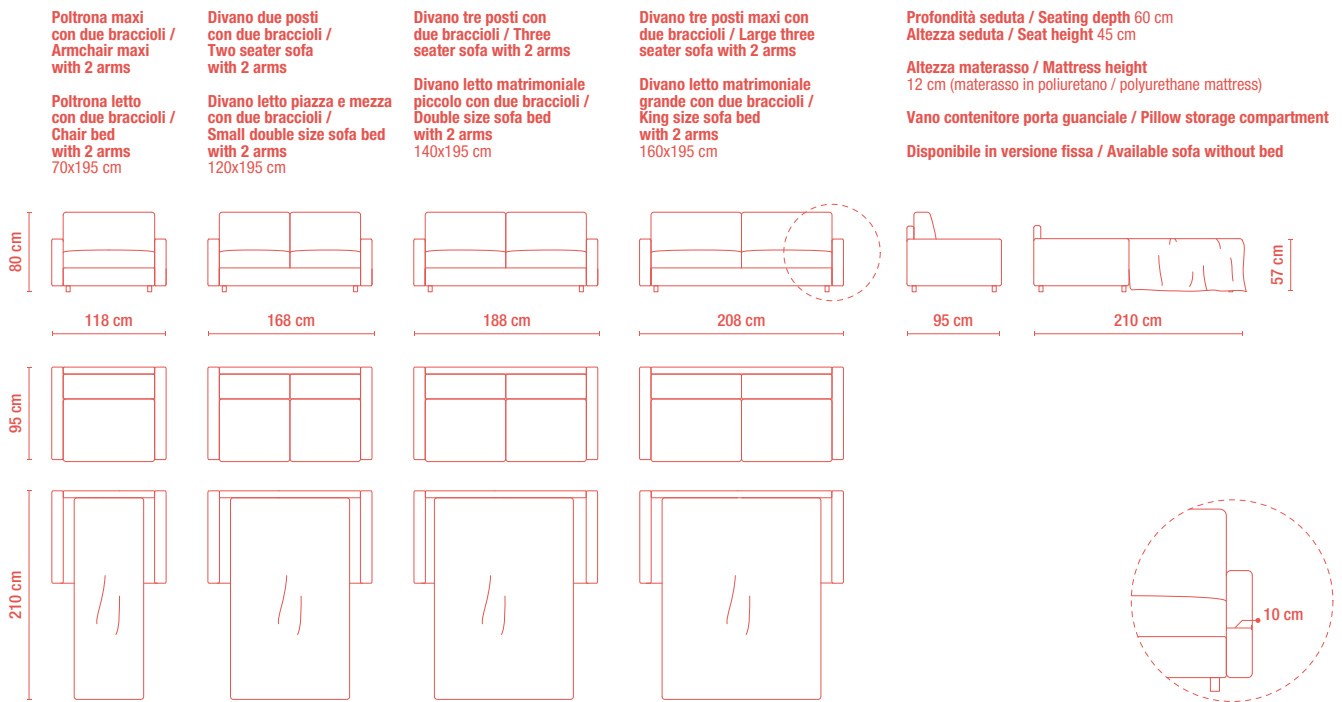

Poltrona maxi con bracciolo sx/dx / Armchair maxi with 1 left/right arm

Poltrona letto con bracciolo sx/dx / Chair bed with 1 left/right arm
70x195 cm

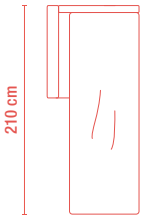
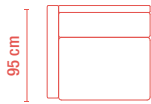
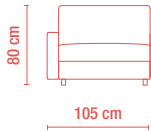

Divano due posti con bracciolo sx/dx / Two seater sofa with 1 left/right arm

Divano letto piazza e mezza con bracciolo sx/dx / Small double size sofa bed with 1 left/right arm
120x195 cm

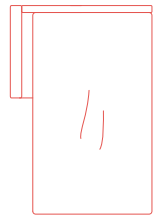
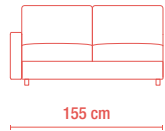

Divano tre posti con bracciolo sx/dx / Three seater sofa with 1 left/right arm

Divano letto matrimoniale piccolo con bracciolo sx/dx / Double size sofa bed with 1 left/right arm
140x195 cm

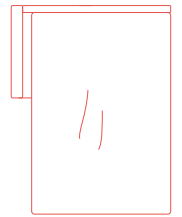
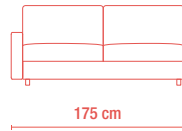

Divano tre posti maxi con bracciolo sx/dx / Large three seater sofa with 1 left/right arm

Divano letto matrimoniale grande con bracciolo sx/dx / King size sofa bed with 1 left/right arm
160x195 cm

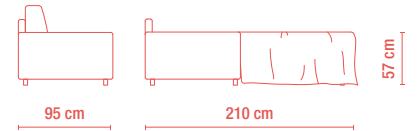
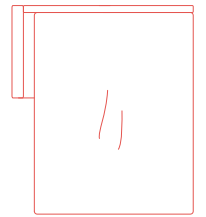
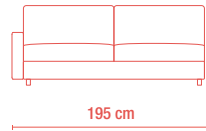

Poltrona lunga stretta con due braccioli senza contenitore / Narrow chaise longue with 2 arms without glove compartment

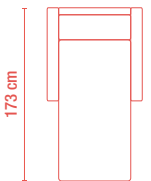
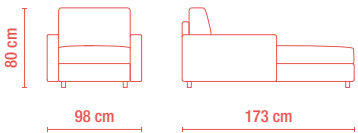

Poltrona lunga stretta con bracciolo sx/dx senza contenitore / Narrow chaise longue with 1 left/right arm without glove compartment

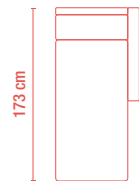
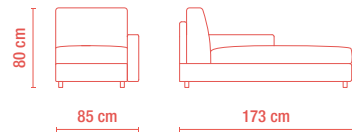

Poltrona lunga stretta senza braccioli senza contenitore / Narrow chaise longue without arms without glove compartment

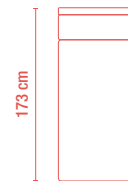
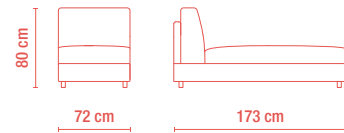

Poltrona lunga larga con due braccioli con contenitore / Large chaise longue with 2 arms with glove compartment

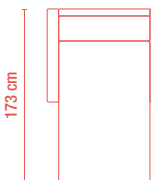
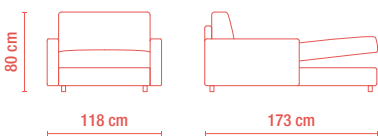

Poltrona lunga larga con bracciolo sx/dx con contenitore / Large chaise longue with 1 left/right arm with glove compartment

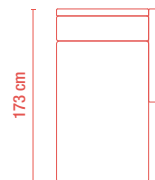
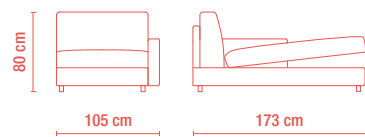

Poltrona lunga larga senza braccioli con contenitore / Large chaise longue without arms with glove compartment

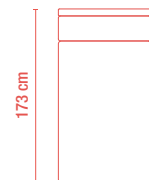
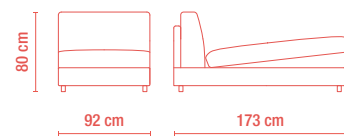

Struttura Struttura in acciaio rivestita in poliuretano espanso e fibra. **Mec-**
canismo Meccanismo del letto in acciaio, verniciatura a polveri epossidiche,
meccanismo con apertura a libro mediante ribaltamento della spalliera, sup-
porto per dormire in doghe larghe in faggio stratificato anti affossamento.
Imbottitura Poliuretano espanso senza CFC a quote differenziate e ovatta
poliestere. **Materasso** Materasso in poliuretano espanso H 11 cm a una
densità 25 kg/m³. **Sfoderabilità** Poltrona completamente sfoderabile.

Structure Steel frame upholstered in polyurethane foam and fibre. **Bed me-**
chanism Steel bed mechanism with epoxy powder coating and book-sty-
le opening system with backrest tilt; laminated beech wide slats anti-sag
sleeping base. **Padding** CFC-free polyurethane foam with differentiated
densities, covered with polyester wadding. **Mattress** Polyurethane foam
mattress, 11 cm thick (density 25 kg/m³). **Removable covers** Fully remo-
vable upholstery.

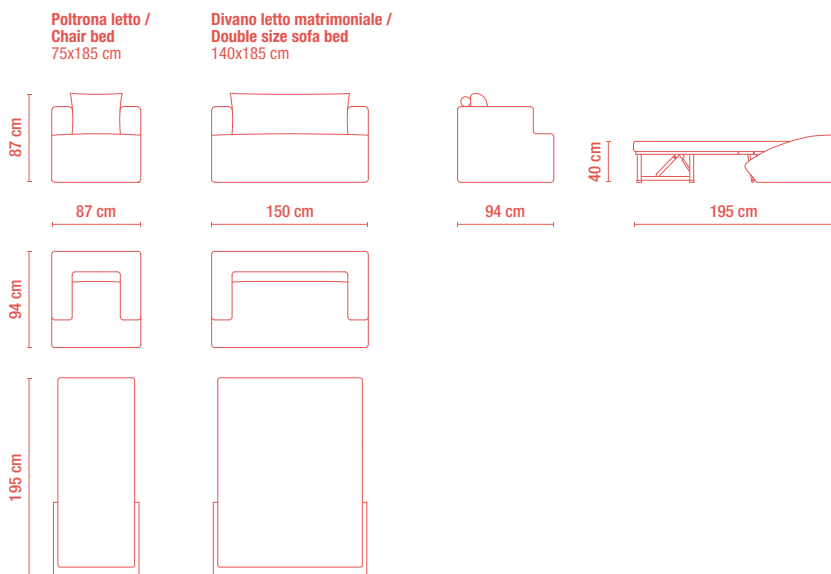

Profondità seduta / Seating depth 53 cm
Altezza seduta / Seat height 45 cm

Altezza materasso / Mattress height
11 cm (materasso in poliuretano / polyurethane mattress)

Struttura Struttura in plastica rivestita in tessuto e fibra poliestere. **Mate-**
ressino Materassino gonfiabile in PVC con pompa integrata H 20 cm, tec-
nologia in fibertech, peso massimo supportato 225 kg. Tempo di gonfiaggio
3 min circa. **Sfoderabilità** Materasso completamente sfoderabile.

Structure Plastic structure upholstered in fabric and polyester fibre. **Mat-**
tress pad Inflatable PVC mattress pad with integrated pump, 20 cm high,
FiberTech™ technology, maximum supported weight 225 kg, approx. 3-mi-
nute inflation time. **Removable covers** Mattress pad fully removable.

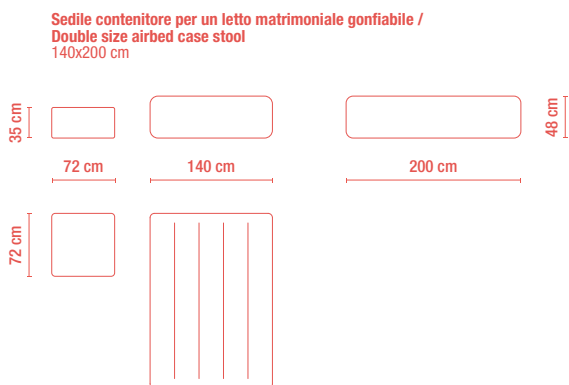

Profondità seduta / Seating depth 72 cm
Altezza seduta / Seat height 35 cm

Altezza materasso / Mattress height
48 cm (materasso in PVC gonfiabile / inflatable PVC mattress)

**FOTOGRAFIA /
PHOTO:**

Luca Attilio Caizzi
Vincenzo Caccia
Michele Foti
Giovanni Emilio Galanello
Arnaldo Genitrini
Ezio Prandini
Efrem Raimondi
Romano Fotografie

**ILLUSTRAZIONI /
ILLUSTRATIONS:**

Steven Guarnaccia

**PROGETTO EDITORIALE /
EDITORIAL DESIGN:**

Memesi
Como - Italy

**STAMPA /
PRINT:**

Grafiche Antiga
Crocetta del Montello
(Treviso) - Italy

**CARTA /
PAPER:**

Arena Natural Rough, Fedrigoni, 300 g/m²
Arena Natural Rough, Fedrigoni, 120 g/m²
Magno Volume, Sappi, 130 g/m²
Nautilus Classic, Mondi, 100 g/m²

**SI RINGRAZIA /
WE THANK:**

Alvar Aalto
Gae Aulenti
Nina Bassoli
Marcenaria Baraùna
Simone Cassetta
Achille Castiglioni
Casa Cesare Cattaneo
Cappellini
Mario Ceroli
Carlo Dal Bianco
Riccardo Dalisi
Paolo Deganello
Elisa De Nofa
Domodinamica
Fondazione Ca' Romanino
Fondazione Vico Magistretti
Jaime Hayon
Layuhl Jang
Shiro Kuramata
Ugo La Pietra

Giovanni Levanti
Italo Lupi
Tomaso Macchi Cassia
Marcello Maranzan
Enzo Mari
Alessandro Mendini
Alzek Misheff
Aldo Mondino
Martinelli Luce
Fabio Novembre
Pierluigi Nicolin
Rossana Orlandi
Francesco Paleari
Margherita Pellino
Man Ray
Denis Santachiara
Small Small Space
Torre al Parco
Arturo Vermi
Zoll

Campeões



CAMPEGGI

22040 ANZANO DEL PARCO (COMO)

TELEFONO +39 031 630 495

CAMPEGGIDESIGN@CAMPEGGIDESIGN.IT

WWW.CAMPEGGIDESIGN.IT

IG @CAMPEGGIDESIGN